

SaunaFin Cedar Barrel Sauna Assembly Instructions

Please read and understand the complete instructions prior to assembly and use of your sauna. Customer agrees not to hold SaunaFin Inc. and any of its authorized dealers liable for improper installation, maintenance and repair of this product



Requirements:

- 2 People (recommended)
- * Carpenter's Hammer
- * Step Ladder
- * Cordless Drill (we supply the bit)
- * Tape Measure
- Carpenter's Level
- * Rubber Mallet

SaunaFin

Cedar Barrel Sauna Assembly Instructions

Index

Sauna Base Preparation (Standard) – Page 3

Sauna Barrel Assembly (Standard) – Page 4 to 15

Standard Bench Installation (Standard) – Page 16 to 19

Signature Bench Installation (Option) – Page 20 to 25

Lounge Bench Installation (Option) – Page 26 to 29

Cedar Bevel Roof Installation (Option) Page 30 to 32

Electric Heater Installation (Option) – Page 33 to 35

Wood Heater Installation (Option) – Page 36 to 37

Harvia Wood Heater Installation (Option) – Page 38 to 41

Sauna Vent Kit (Option) – Page 42 to 43

Sauna Light (Option) – Page 44 to 45

Cove Assembly (Option) – Page 46 to 47

Completion/Maintenance/Warranty – Page 48 to 50

SaunaFin

Cedar Barrel Sauna Assembly Instructions

Sauna Base Preparation

A solid base for your sauna is recommended and can be made from any of the following.



Concrete Pad



Wooden Deck



Crushed Gravel



Patio Stones/Paver Blocks

(Refer to the below chart for minimum base requirements)

It is recommended to build a base larger than required to provide a sitting area for cooling off during your sauna session.

Sauna Size	6'x6' (182x182)	6'x7' (182x214)	6'x8' (182x244)	7'x6' (214x182)	7'x7' (214x214)	7'x8' (214x244)
Minimum Base Size	48"x60" (120x150cm)	48"x72" (120x183cm)	48"x84" (120x213cm)	60"x60" (150x150cm)	60"x72" (150x183cm)	60"x84" (150x213cm)
Options						
Porch	Add 24" (60cm) to total length.					
Changeroom	Add 48" (120cm) to total length.					

**** All measurements in above chart are "width x lengths"***

SaunaFin

Cedar Barrel Sauna Assembly Instructions

***Please note that the number of Barrel Cradles supplied depends on the overall length of the sauna.**

***Saunas with an overall length under 10' (305cm) or greater have 2 cradles while saunas that are 10' (305cm) to 12' (366cm) have 3 and any saunas over 12' (366cm) have 4 Cradles.**

***Please Refer to the diagram on the right for the correct configuration of your sauna and options. (if any)**

A - Stave with dado groove for barrel sauna only.



B - Stave with dado grooves for barrel sauna & 2' porch



C - Barrel sauna, 4' Changeroom and 2' Porch.



D - Barrel sauna and 4' Changeroom.



Inset. 1

Make sure the placement for your sauna is level with a slight slope to the back for drainage.

Start by layin out the cradles.

Lay the first bottom stave in the center of the cradles.

This stave will have convex edges on both sides as in inset.1.

Mark the centre of the cradles horizontally. Fig. 2a



Fig 2a

Measure 5" (13cm) from each end of the stave to the cradles, as shown. Fig. 2b



Fig 2b

SaunaFin

Cedar Barrel Sauna Assembly Instructions



Secure stave into cradle using 2 ½" (64mm) screws.

Repeat for remaining cradles.

****Always ensure that you have the correct screw length so that there will be enough thread to hold, and especially, so that the screw does not go all the way through the material and come out the other side.***



Start laying down the wall staves. Keep the dado grooves in line with the correctly positioned bottom stave.



Make sure the staves are flush.

Continue placing the staves until you get to the end of the cradles on each side.



Place the back wall into the dado grooves closest to back of sauna.

Make sure the back wall panel is centered with the middle stave.

****The back Wall will not have the square cut out if ordered with the electric heater option.***

SaunaFin

Cedar Barrel Sauna Assembly Instructions



Use rubber mallet to tap wall into back groove.



Repeat this process to install the door panel on the front wall.

Make sure the door is centered with the middle stave.



Use the top stave to go from the front wall to back wall to help stabilize the sauna.

*** The top stave has 2 concaved edges as in inset 2.**

Inset. 2



Using your carpenter's level and rubber mallet, level up the front and back walls.

SaunaFin

Cedar Barrel Sauna Assembly Instructions



Install the front half moon side wall panels.

Screw into place at the top and bottom with
2 ½" (64mm) screws.

****Please note: Panels may be not be exact size to middle wall. (Pic 1 & 2 below.)
Center the half moon panels vertically on the middle wall and secure in place.***

Pic. 1



Pic. 2



SaunaFin

Cedar Barrel Sauna Assembly Instructions



Repeat for back wall.

** Note that the bench brackets face inside of sauna.*



Once both ends are on, start installing the wall staves.



Use the rubber mallet to finesse them into place.



Install a few staves at a time, alternating sides.

SaunaFin

Cedar Barrel Sauna Assembly Instructions



Secure every 2nd stave on the bottom of the sauna with the provided 2 ½" (64mm) nails to hold staves in place.
(If required)



When installing the staves, tap tightly together while leaving as much of a gap as possible between stave and wall using the pencil line as a guide as in picture.

** This will make the tightening of the bands easier.*



Continue to add staves on both sides to the top.



When you reach the top, you will find that the last wall stave doesn't look like it fits properly, this is normal.

SaunaFin

Cedar Barrel Sauna Assembly Instructions



Assemble the steel bands by sliding the rod with a nut on one end through the other and secure with a second nut.



Slide the band over the front of the sauna about 2" (5cm) from the edge of the stave.

Repeat the process for the back of the sauna.



For the middle bands, toss one end over the sauna while pushing the other underneath.

***If a porch and/or changeroom option is chosen, the bands should be positioned over top of where the walls are.**



Measure all around the sauna to ensure the measurement of the bands are consistent.

Secure band in same manner as previous step.
Snug up bands with the cordless drill.

SaunaFin

Cedar Barrel Sauna Assembly Instructions



Use the rubber mallet to tap the staves out & in as needed to get the last wall stave and top stave to sit properly together.

Tap up (from the inside of the sauna so you don't break the ends) or down, by hammering on the band to attain a uniform circle shape.



When the wall staves take on the proper shape, tighten the steel bands a little more snug.

Continue to use the rubber mallet to finesse the staves into place until they look just about perfect.



Make sure ends of sauna are flush.

Adding a Spacer to the Top Sauna Stave

In your sauna package you will find a spacer stave that is square on both sides that is only required if there happens to be a "gap" after installing all of the staves, (as in Fig.1)

You will need to follow the following instructions to add this spacer to the top special stave.

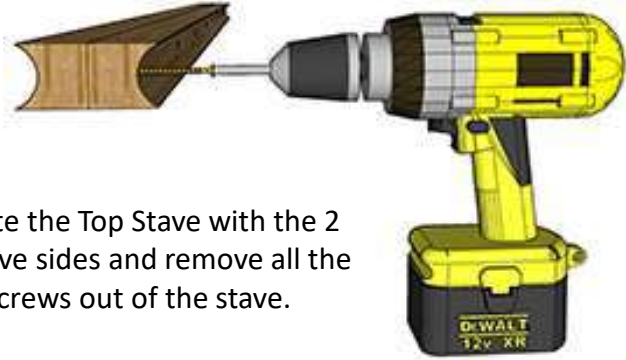
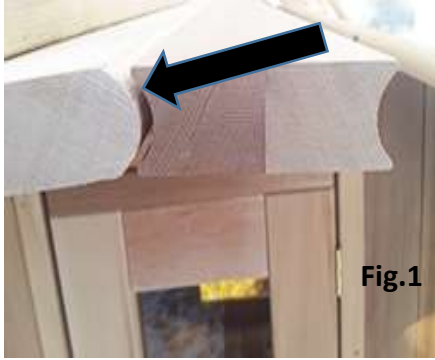

Locate the Top Stave with the 2 concave sides and remove all the screws out of the stave.



Insert square spacer in between the two stave halves.

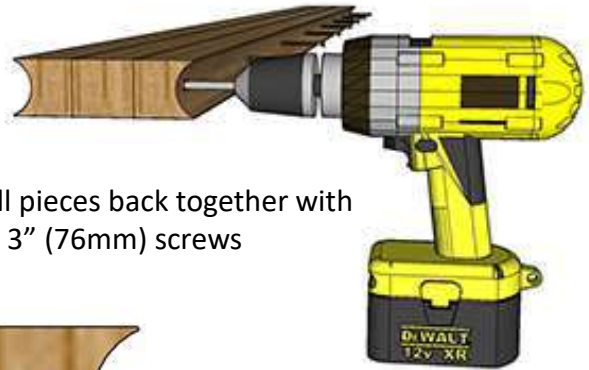

Screw all pieces back together with 3" (76mm) screws



Reinstall the now wider Top Stave following the sauna assembly instructions.

Tips to follow when adding the spacer to the top stave

Do not assemble the sauna when the wood is wet, allow it time to dry out after being exposed to moisture.

Loosen the bands so you have enough room to maneuver the staves underneath them.

If you run out of threads on the bolts and the bands are not tight enough,, that's usually an indication that you need to add a spacer to the top stave.

Making the Top Sauna Stave narrower

In rare instances, your sauna staves will be too tight not allowing the staves to settle into position correctly. (as in picture)

This doesn't happen often and the sauna staves and bands are always better being as tight as possible.



You will need to follow the following instructions to make the top special stave narrower.

Locate the top special stave and remove all the screws.

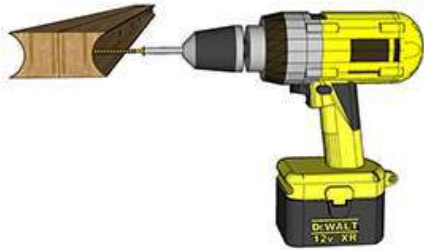

Measure from flat edge 3/4 " (2cm) on each stave and safely cut to make staves thinner.

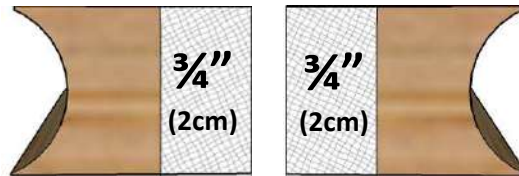

A circular saw or table saw is best for cutting the staves. Follow all of your saws safety precautions when cutting staves.

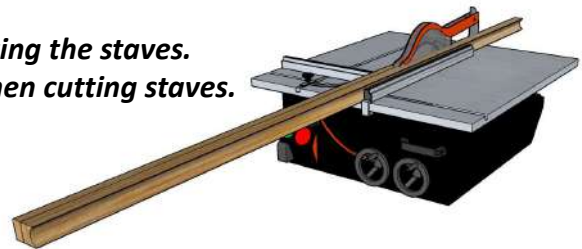

Screw the 2 pieces back together with 2" (64mm) screws

Reinstall the now narrower Top Stave following the sauna assembly instructions.

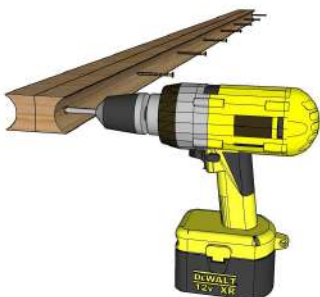

SaunaFin

Cedar Barrel Sauna Assembly Instructions



The front and back bands should be 2" (5cm) from the end of the staves.

*** Space out middle bands according to sauna size and how many bands are included.**



Tighten all bands as tight as possible.

*** Don't be worried about making them too tight, you cannot overtighten!**



Center out the door handle (small) on outside of the door and secure with 2" (51mm) screws using the pre-drilled holes.

***Magnets are very strong and may require some force to pull the door open the first time.**



Repeat this process for the inside handle installing it at desired height centered horizontally on door.

*** If the Changeroom option is ordered, install the inside and outside handles in the same manner.**

SaunaFin

Cedar Barrel Sauna Assembly Instructions



Install towel hanger at desired height on outer wall using 1 ½" (38mm) screws.



If ordered, Install the thermometer centered above the door using a 1 ½" (38mm) screw.

- *The main structure of your Cedar Barrel Sauna is complete.*
- *Please refer to each of the remaining sections to install the various upgrades and options chosen.*

Benches

**Standard*

**Signature*

**Lounge*

Heater

Saaku Electric

Standard Wood Burning Stove

Harvia M3 Wood Burning Stove

SaunaFin

Cedar Barrel Sauna Assembly Instructions

The flat floor (If Purchased) Is shipped semi assembled.
You will need to add the bottom support onto the floor before assembling the benches.
** Note that the middle support is only included in 7' diameter Saunas**

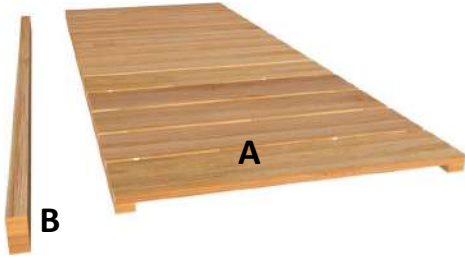

Locate the flat floor (A) and bottom support (B).



Flip over flat floor, measure the center and place the bottom support in the center.



Secure the bottom support to the bottom of the flat floor using 1 ½" (38mm) screws in the pre drilled holes.



Flip the flat floor back over and it is ready to be installed inside the sauna.



Start the assembly of your standard benches by installing the flat floor.
(If Purchased)



Ensure the flat floor is centered in sauna and that it is level, you can use the door frame to confirm it is level.

SaunaFin

Cedar Barrel Sauna Assembly Instructions



To begin, Bring in the long sauna benches.



Place the long benches down on the wall brackets and then snug up against the back wall.



Secure benches to wall supports by attaching with 1 ½" (38mm) screws.

Ensure to screw in between the bench seat slats so that the screws are not visible.



Space out the bench supports under the crossers on the bottom of the benches.

SaunaFin

Cedar Barrel Sauna Assembly Instructions



Screw the bench supports from the bottom up using 3- 1 ½" (38mm) screws in each support.



Secure the support leg to the floor using a 2 ½" (64mm) screw in each support.

Repeat above steps for opposite bench.



To install the standard porch seats, screw the legs into the end of the seats with 2 ½" (64mm) screws.

Attach the angled brace from the seat to the leg with 2 ½" (64mm) screws.



Use a level or carpenters square to make sure the porch seat is level.

SaunaFin

Cedar Barrel Sauna Assembly Instructions



Secure the porch seat to the front wall from underneath using (3) - 2 ½" (64mm) screws.



Screw the front of the porch seat into the wall from the outside using a 2 ½" (64mm) screw.

Repeat for standard porch bench on other side.



Secure the leg to the floor using a 2 ½" (64mm) screw.



Repeat on other porch bench ensuring they are level with each other.

SaunaFin

Cedar Barrel Sauna Assembly Instructions

The flat floor (If Purchased) Is shipped semi assembled.
You will need to add the bottom support onto the floor before assembling the benches.
** Note that the middle support is only included in 7' diameter Saunas**

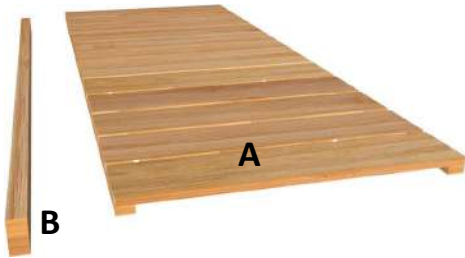

Locate the flat floor (A) and bottom support (B).



Flip over flat floor, measure the center and place the bottom support in the center.



Secure the bottom support to the bottom of the flat floor using 1 ½" (38mm) screws in the pre drilled holes.



Flip the flat floor back over and it is ready to be installed inside the sauna.



Start the assembly of your standard benches by installing the flat floor.
(If Purchased)



Ensure the flat floor is centered in sauna and that it is level, you can use the door frame to confirm it is level.

SaunaFin

Cedar Barrel Sauna Assembly Instructions



Position the front wall enclosure at the edge of the flat floor to determine the seat bracket height.

*** Do not Fasten yet!**



Using the front enclosure as a guide, Install the wall brackets with 3 pcs 2 ½" (64mm) screws, again making sure they are level with the sauna walls or door and flush with the top of the front enclosure.

Repeat for all 4 sides.

(2 on the front wall and 2 on the back wall)

*** Remove the front wall enclosures from the sauna.**



Bring both sauna bench seats in and place on sauna wall brackets

*** Do not fasten yet.**



SaunaFin

Cedar Barrel Sauna Assembly Instructions



Place the 4 seat brackets under the benches lined up with the curved seat support bracket on bottom of bench.



Using 1- 2 ½" (64mm) screw, fasten the bottom of the seat bracket to the bottom stave of barrel sauna.



Screwing from the bottom up into the seat support bracket, use 3 – 2 ½" (64mm) screws to secure the seat bracket to the bench



Install the front enclosure by fastening to the front and back sauna wall with 2 ½" (64mm) screws.



4 screws in each enclosure, 2 in front and 2 in the back. Screw between the slats to make screws less visible.

SaunaFin Cedar Barrel Sauna Assembly Instructions



Screw the seats in place using the same method as in previous step.



4 screws in each seat, 2 in front and 2 in the back. Screw between the seat boards to make the screws less visible.



Screw the front enclosure and the bench seats together on the front tabs with 2 ½" (64mm) screws.

Pre drill these holes first to prevent splitting!



To install the signature back rest, position on wall at desired height and fasten with 2 ½" (64mm) screws.

**** Place screws under the top board in the vertical uprights to keep them less visible.***

SaunaFin

Cedar Barrel Sauna Assembly Instructions



To install the porch signature bench, first position the floor making sure it is level.



Secure the sauna floor to the sauna staves with 2 ½" (64mm) screws.

** Screwing between the floor boards will make the screws less visible.*



On a clean flat surface, assemble the porch bench and front wall enclosure using 2 ½" (64mm) screws into the pre drilled pocket holes.

SaunaFin

Cedar Barrel Sauna Assembly Instructions



Position the assembled bench on the porch floor and up against the front wall of the barrel Sauna.

Using a level, make sure the bench is level and square to the porch floor..



Fasten the assembled porch bench to the front wall using 2 ½" (64mm) screws.
(5pcs- 3 on the seat and 2 on the front wall enclosure)



Screw the front of the porch seat into the sauna wall from the outside using a 2 ½" (64mm) screw.

Repeat for signature porch bench on other side.

***Congratulations on the assembly of your
SaunaFin
Signature Bench!***

SaunaFin

Cedar Barrel Sauna Assembly Instructions

The flat floor (If Purchased) Is shipped semi assembled.
You will need to add the bottom support onto the floor before assembling the benches.
** Note that the middle support is only included in 7' diameter Saunas**

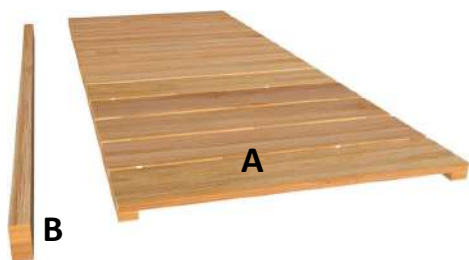

Locate the flat floor (A) and bottom support (B).



Flip over flat floor, measure the center and place the bottom support in the center.



Secure the bottom support to the bottom of the flat floor using 1 ½" (38mm) screws in the pre drilled holes.



Flip the flat floor back over and it is ready to be installed inside the sauna.



Start the assembly of your standard benches by installing the flat floor.
(If Purchased)

SaunaFin

Cedar Barrel Sauna Assembly Instructions



Install the flat floor in the middle of the sauna making sure it is level.



Using the pre drilled holes, assemble the lounge bench support to the longer front lower bench wall using 2" (51mm) screws.



Position assembly in place and secure to sauna walls and floor using 5- 2 ½" (64mm) screws on the top and bottom rails.

**Be careful not to screw into any stave joints.*



Place lounge bench on top of bench support.

SaunaFin

Cedar Barrel Sauna Assembly Instructions



Ensure bench is flush with the bench support and secure with 2 ½" (64mm) screws in the pre drilled holes.

** If sauna is purchased with wood burning heater, repeat process for opposite bench.*

** If electric heater is chosen, continue onto next step.*



Assemble bench support to the short front lower bench wall in the same manner as in opposite bench.

Secure to floor and walls ensuring bench is level.



Ensure bench is flush and secure with 2 ½" (64mm) screws between the seat boards so the screws are less visible.



Install backrest with 2" (51mm) screws at desired height making sure that the lounge bench can still operate correctly.

Repeat for other side.

SaunaFin

Cedar Barrel Sauna Assembly Instructions



If the porch option is selected, start by installing the floor ensuring it is level.

Secure with 2" (51mm) screws between the floor boards into the barrel wall.



Assemble the 2 pieces for the porch seat together using 2 ½" (64mm) screws.



Fasten bench to floor and sauna wall using 3 - 2 ½" (64mm) screws on the top and bottom.

Repeat process for other bench.



Congratulations on the assembly of your

SaunaFin Lounge Bench!

SaunaFin

Cedar Barrel Sauna Assembly Instructions



Unroll the EPDM membrane over the top of the sauna.
Even out the membrane over the sides of the sauna.



Starting at one end of the sauna, pull the membrane tight and secure to the edge of the staves with staples.
Using a utility knife, cut off the excess rubber flush to the edge of the staves.



Pull the membrane tight at the other end of the sauna and follow the same steps of stapling then cutting the excess off.



Center one of the trim pieces at the top of the sauna flush with the bottom edge of the staves.

Fasten the trim piece using a 2" (51mm) screw.

Only use 1 screw per piece at this time.

SaunaFin

Cedar Barrel Sauna Assembly Instructions



Add the next piece of trim flush to the first piece and secure with a 2" (51mm) screw.

Continue attaching the remaining trim pieces following the same process as the previous step.



Once all of the trim is on and fits nicely, add 2 more screws to each piece of trim.



Repeat the same process for the other end of the sauna.
Cut off any excess membrane sticking out past the trim using your utility knife.



Line up your first piece of bevel siding with the wide end flush with the edge of the middle stave.

Fasten the bevel siding to the sauna using a staple gun with 1 ¼" (32mm) crown staples.

When stapling, Be careful not to hit the aluminum bands.

SaunaFin

Cedar Barrel Sauna Assembly Instructions



Use the provided spacing blocks as shown to get the correct placement of the next piece of bevel siding.

Fasten the siding in the same manner as the previous step.



Continue adding the bevel siding using the spacer block working your way up the sauna.

Use as many staples as possible to secure the siding to the sauna.



When you have installed the bevel siding up to the top, start installing the other side following the same process.

Fasten the remaining pieces of bevel siding in the same manner alternating sides until the siding overlaps at the top.



Use one last piece of the bevel siding to overlap the 2 sides.

Staple both sides of this piece to secure firmly.

SaunaFin

Cedar Barrel Sauna Assembly Instructions

*The following installation instructions are for the Helo Cup (Saaku) electric heater.
Always refer to the original sauna heater manual for confirmation.
Always Read all instructions carefully.*



Measure the proper distances for the heater template according to the heater manufacturers instructions.



Using the template provided, drill four 9/64" holes to fasten the heater to the wall.

Install the two 1/4" x 1 1/2" (6mm x 38mm) hex head lag screws (supplied with the heater) into the upper two holes.



Tighten these screws until their heads are about 1/4" (6mm) from the wall.

SaunaFin

Cedar Barrel Sauna Assembly Instructions

*The following installation instructions are for the Helo Cup (Saaku) electric heater.
Always refer to the original sauna heater manual for confirmation.
Always Read all instructions carefully.*



Hang the heater on the two upper screws.

Install the two ¼" x 1" (6mm x 25mm) hex head lag screws (supplied with the heater) into the two lower mounting holes.

Tighten all 4 hex head lag screws to lock the heater in place.



Rinse the rocks with water before placing in the heater.

Carefully place the rocks loosely so that the air can circulate through the heater.

Packing the rocks too tightly may cause the heater high limit switch to trip.

The rocks must fully cover the heating elements.

****Operate the heater for an hour with the sauna door fully open to burn off any residual coating from the manufacturing process before using.***



****The wiring for the electric heater most times enters the sauna underneath the heater as shown in the above 2 pictures.***

• All wiring should be installed according to the heater manufacturers instructions and by a licensed electrician.

• **Do NOT use a G.F.I breaker**

Electric Heater Installation (Option)

SaunaFin

Cedar Barrel Sauna Assembly Instructions



Locate the pieces for your heater guard.
The heater guard contains 2 Assembled side pieces, 2 heater guard supports and hardware.

Stand the 2 Assembled side pieces of the heater guard on edge with pre-drilled holes on the bottom.



Screw heater guard support to either side using (2) – 1 ½” (38mm) screws per side.

Assemble remaining heater guard support to the 2 ends in the same manner as previous step.



Place assembled heater guard around electric heater and screw to wall using (4) 2 ½” (64mm) screws.

****Make sure heater guard is level before securing.***

Wash the layer of rock dust off of the sauna rocks before using them.

When your sauna is set up and working you should “break-in” the sauna before using it for the first time by turning on the heater to its highest setting and operate it for about 1 hour.

This is recommended to burn off any oils and impurities from manufacturing, and it also “cures” the woodwork.

After about ¾ hour, slowly pour about one litre of cold water on the rocks.

It should all turn to steam and not come out of the bottom of the heater. If it does, you’re pouring too fast.

SaunaFin

Cedar Barrel Sauna Assembly Instructions



To install the wood burning heater, lift the heater into the hole in the back of the sauna.

*** Woodstove is very heavy and 2 people are recommended for lifting.**



Secure the wood stove with the provided 1 ½" (38mm) lag screws.

Repeat for all 16 holes.

*** Do not overtighten as this will strip the screws.**



Attach the chimney elbow to the wood burning stove by pushing the provided bolts into place and hand tightening the nuts on the other side.

Repeat for all 4 corners.



Using a wrench to hold the nut on the inside, tighten the bolts completely with an impact drill or a wrench.

SaunaFin

Cedar Barrel Sauna Assembly Instructions



Insert the flanged end of the chimney head onto the elbow firmly.

** Some finessing may be required.*



Ensure that the flanged end of the chimney is securely in place



Rinse the rocks with water before placing in the heater.

****Operate the heater for an hour with the sauna door fully open to burn off any residual coating from the manufacturing process before using.***

SaunaFin

Cedar Barrel Sauna Assembly Instructions



Start by removing all protective film from stainless steel parts before installation.



Install floor protecting sheet against back wall centered between benches.



Install back wall shield centered over chimney hole with 1 ½" (38mm) screws.



Remove the rear chimney cover from the stove.

SaunaFin

Cedar Barrel Sauna Assembly Instructions



Insert the Chimney adapter into rear hole tapping with a rubber mallet until it is snug.



Bring stove into position, centered in front of hole, about 6" (15cm) away from wall.



Place the short connector through the hole in the sauna from the outside.



Slide short connector onto chimney adapter.

SaunaFin

Cedar Barrel Sauna Assembly Instructions



Insert the “T” connector to the short connector ensuring it is straight.

Secure with provided screws.



Attach the chimney cover plates using 1 ½” (38mm) screws ensuring halves are level.

****Top Plate should overlap the bottom plate.***



Attach middle chimney connector to the “T” with provided screws.



Attach rain guard to top chimney piece and secure with provided screws.

SaunaFin

Cedar Barrel Sauna Assembly Instructions



Wrap the chimney support strap around chimney and use the provided nut and bolt to secure.

**Snug up only hand tight*



Attach chimney support braces to the sauna using 1 ½" (38mm) screws. Ensure not to screw into any seams.



Tighten up the chimney support brackets with a 7/16" (11mm) socket or wrench until snug.



Attach chimney top onto chimney and secure with provided screws.

SaunaFin

Vent Kit Assembly Instructions

(Optional)

In most cases, venting is not required for proper sauna function, however it increases air flow circulation as well as ventilation when the sauna is not in use.

Many people prefer not to install vents in pre fabricated saunas.

Generally, you have access to add a vent to your sauna once assembled if it is deemed necessary.

Vent Kit

Contents

Stainless Steel 3"x 7" Grill (X2)

Cedar Vent Cover

1 ½" Stainless Steel screws (X13)

Tools Required

Hole saw or drill bit to drill holes

Cordless Drill

Robertson bit



The Location of the vent depends on the type of sauna purchased and the location of the heater. Use the following instructions as a guide to help you determine where the vent should be located.

Inlet – Low below heater

Outlet – High up at far corner away from heater

Ex. Saunas with the heater on the back wall in the middle, the inlet would go under heater on the back wall and the outlet would go high on the front wall.

Saunas with the heater on the front wall would have the inlet under the heater on the front wall and the outlet high on the back wall for maximum airflow.

For Saunas with wood heaters, get the inlet as close as possible to the wood heater and the outlet high in the opposite corner.

Panoramic Saunas – Follow these guidelines with the inlet holes positioned on the front wall under the heater and the outlet holes being positioned as high up in the opposite corner on the staves.



Inlet under electric heater on Back wall



Inlet beside wood heater on Back wall

SaunaFin

Vent Kit Assembly Instructions

(Optional)



Drill inlet holes centered underneath the heater.
(if sauna is being installed with a wood heater, drill close to the side of the heater)

**** A 2" diameter hole saw was used in pictures but more holes with a smaller drill size will also work)***



Install 1 of the stainless steel vent grills over the inlet holes on the outside of the sauna centered over the holes using 1 ½" screws. (6pcs)



On the wall away from the heater, close to the top, drill the outlet holes in the same manner as the previous step



Install the other Stainless Vent cover over the outlet holes on the outside using 1-1/2" stainless steel screws. (6pcs)



Install the cedar vent cover over the outlet holes on the inside of the sauna with a 1 ½" screw.

**** Tighten screw enough that the vent cover still rotates smoothly.***

Vent Kit (Option)

SaunaFin

Sauna Light Assembly Instructions

(Optional)

If a light is ordered, SaunaFin supplies the light fixture only.

The light switch and any other electric components need to be purchased separately and should be installed according to the light manufacturers instructions and by a licensed electrician.

We cannot supply any other electrical components needed to wire up the light.

For outdoor saunas, you can use weatherproof boxes, conduit and light



Weatherproof Conduit & Light Switch



*Weatherproof Light Switch
(purchased separately)*

If you are installing a light switch on the outside of your sauna, it is recommended to install it outside the door using the appropriate weatherproof conduit and switches.

SaunaFin

Sauna Light Assembly Instructions

(Optional)



Recommend low profile "pancake box" rather than standard octagon box. This can be surface mounted flush inside of the sauna with light fixture fitting over the box.



The best placement for your light would be to the side or above the door on the front wall.
You can also install on the ceiling.

(Do not install light where you may hit your head on it)

Installing the light under one of the benches can create a relaxing ambiance within the sauna that many customers enjoy.

PRODUCT MAINTENANCE:

1. To clean the outside of the fixture, use a dry or slightly dampened clean cloth (use clean water, never a solvent) to wipe the surface of the fixture.
2. To clean the inside of the fixture, first disconnect power to the fixture by turning off the circuit breaker or by removing the fuse at the fuse box. Next, use a dry or slightly dampened clean cloth (use clean water, never a solvent) to wipe the interior surface of the fixture.
3. Do not use any cleaners with chemicals, solvents or harsh abrasives. Use only a dry soft cloth to dust or wipe carefully.

SaunaFin

Cedar Barrel Sauna Assembly Instructions



Line up the cove pieces starting with the smallest pieces on the end and working towards the middle forming a semi circle.

Place 2 ½" screws in the pre-drilled holes to assist in the assembly of the cove.



Center the 2 middle (longest) pieces under the lip of the sauna.

Ensure cove pieces are tight to the wall of the sauna.



Secure with 2 ½" screws from the underneath.



Fasten each cove piece to the next through the pre drilled holes on the front of each piece using a 2 ½" screw

SaunaFin

Cedar Barrel Sauna Assembly Instructions



Continue building the cove from the middle until the cove is complete.



When installed, the cove should be centered and tight together and to the wall of the sauna.

Enjoy your new sauna cove!



Congratulations on the assembly of your new Western Red Cedar Barrel Sauna!



Or to view the assembly process got to:
<https://youtu.be/2xtYPKTLAUg>

SaunaFin www.saunafin.com | 905-738-4017

Completion/Maintenance/Warranty

MAINTAINING YOUR SAUNA AFTER INSTALLATION

Interior

It is recommended to vacuum or sweep out the inside of your sauna frequently to remove dirt and other debris. Under normal conditions, a slight wash of the floor and benches with warm soapy water several times a year will maintain its cleanliness. You can use a sheet of fine grit sandpaper or a low pressure wash to remove more stubborn stains or for a deeper cleaning of the interior of your sauna.

Never use ammonia or harsh cleaners as they can turn the wood gray.

Exterior

Depending on the humidity and weather conditions in your area, the cedar will either shrink or expand based on the amount of moisture absorption. The desired effect is to have the cedar expand into the bands therefore making the sauna staves much tighter.

Over time the lumber will weather naturally as a result of sun and rain, it will change into a weathered grey colour. This natural weathering will not harm the wood or impair the sauna's performance.

If you wish to retain the natural color of your SaunaFin Sauna, there are many cedar stains on the market and almost as many opinions as to which is best.

We encourage you to rely on your own research and referrals.

Recommended Stains Include:

Behr Premium Semi-Transparent Waterproofing Stain & Sealer

Sikkens ProLuxe Cetol SRD Translucent Stain

<https://www.realcedar.com/outdoor/finishing-choices/>

Note: never treat the interior of the Sauna, and never apply paint or varnish to the exterior.

You may need to tighten the bands after a period of time, usually within the first few months.
(Barrel Saunas Only)

Water Seepage

Some minor water seeping into the sauna is expected and normal for an outdoor sauna. If your sauna is properly installed, you should not have water dripping in but you should expect some water seepage, especially on the top and sides of the sauna.

This is due to the porous characteristics of the wood and to the ball-and-socket profile design of the staves.

Water Seepage will not harm the sauna. The moisture will evaporate once you turn on the heater and the sauna heats up.

If the water marks are bothersome, they can be easily removed with a light sanding (80 or 100 grit)

To minimize seepage, select a location for your sauna that is under cover, or choose one of our roofing options.



Normal Water seepage



HOW TO TAKE A SAUNA

1. Pre-heat your sauna to the desired temperature (usually between 80-100°C)
2. While it's warming up, take a nice hot shower.
3. Enter the pre-heated sauna, relax and allow your body to perspire in the soft dry heat. Do not throw water on the rocks during the first part of the session.
4. Cool off with a cold shower or a quick swim in a lake or pool.
5. Re-enter the sauna and sprinkle water on the rocks. This will increase humidity to assist in perspiration. Half a cup every 5 minutes should be enough. Too much water will just cool off the rocks and you'll get less steam.
6. After a 20-30 minute sauna, cool off in the shower or lake or pool.
7. Repeat this sauna/cold shower process as often as desired.
8. After each use, leave the door fully open for a few hours if possible so the wood can dry out.

**These are guidelines only. Enjoy your sauna in whichever way you desire.
Children must be supervised by an adult.**

WARRANTY

Manufacturer Inc. warrants our saunas against defects in materials and workmanship under normal/residential use for a period of five (5) years, as applicable, from the date of receipt of the product by the original end-user consumer. This warranty does not apply to normal wear and tear and/or natural weather conditions. This warranty does not cover regular required maintenance of the sauna, (eg. Tightening bands on the barrels, cleaning or staining the sauna) refer to your sauna assembly manual for maintenance guidelines. This warranty does not cover misuse or negligence and the manufacturer and associated retailers are not liable for any injury or damage caused by the product. This warranty is a parts only warranty and any service or labor costs would not be considered as part of the 5 year warranty.

Purchaser Name: _____ Date: _____

Purchased From: _____