

LK PLUS & LK PREMIUM SAUNA LINER KITS

(USE FOR ALL KITS WITH 2x4 BENCH TOPS)

***** BEFORE YOU BEGIN: READ ALL THE WRITTEN AND DRAWN INSTRUCTIONS AND REVIEW THE MATERIAL LIST *****

Remember the old carpenters proverb: "Measure Twice, Cut Once."

***** SPECIAL NOTE FOR CONTRACTORS: *****

We realize you already possess the skills to build the sauna and you may choose not to read these instructions. At the very least, make sure you carefully review the material list before you begin cutting.

Material is supplied in specified lengths for particular uses.

Confirm cedar direction on ceiling.

The kit has been counted twice before it leaves our factory. 95% of the time, "shortages" are a result of certain pieces being cut incorrectly, leaving a shortfall elsewhere.

CEDAR GRADING AND SELECTION:

Clear cedar kits use the finest "Grade 'A' & Better" tongue & groove cedar for lining material. But even with this top grade, you may find certain boards that you do not like. Pre-sort your sauna kit to find this material and make an effort to "hide" these boards. Install these boards behind the bench where they will not be visible. In the case of front wall boards, cut them so that you can hide less attractive boards behind the heater.

The cedar is finished on two sides to give you more flexibility in selecting the face you prefer.

When assembling benches, select nicer side to be bench top.

YOUR SAUNA DETAILS

Material List itemizes lengths provided and for which wall (based on quotation and order placed).

Do NOT reassign or reallocate material without first speaking with us.

The material supplied for ceiling is clearly indicated.

If the material delivered does not correspond to your sauna design or layout, contact us before you install. Do not cut down boards intended for something else. We will not provide additional material in these circumstances.

FRAMING:

This instruction manual has no details for general framing. It is assumed that you possess basic carpentry skills to install this kit and have the know-how to frame the walls and hang a door.

The instructions note blocking as required to support the benches and heater.

Use 2" x 4" kiln-dried SPF (spruce, pine, fir) studs to frame the walls and ceiling.

Unless otherwise specified, kits up to 8' x 8' are lined horizontally (**drawing #1**). Kits over 8'x 8' are usually lined vertically and should be strapped horizontally (see drawing #2B).

Standard framed height is 83-1/2". (Check material list to **confirm your sauna height** as ordered.)

Provide extra blocking for heater mounting brackets and bench cleats (supports). (**See drawing #3 & #4**).

See Material list for your door rough opening.

Frame the walls at 16" on centre. If the walls are already framed and you wish to change the direction, they should be strapped using 1" x 2" spruce strapping at 16" on centre.

FRAME SIZE:

Frame sauna to to size ordered (see material list).

For example, if sauna is 5' x 7', frame walls to 5' x7'. Actual sauna interior will be about one inch smaller.

Unless otherwise ordered, standard framed height is 83-1/2"



Check	Quantity	Length	Description
✓	32	6	1x4 t & g ceiling
✓	29	8	back-of-door cleats
✓	54	6	front
✓	25	6	
✓	2	8	Extra t & g
✓	2	6	Extra t & g



VENTING: (see vent drawings #1, #6 & #7)

Sauna venting does not mean exhaust venting as you would for a shower. The purpose of venting is to optimize sauna function. To pull hot air from heater and drag it to the far corner. Inlet and outlet vents should be on opposite sides. They should not be on same wall. Sauna venting goes from inside house to inside house. Do not vent to the outdoors. (Outdoor saunas present an enigma. In general, for outdoors, you have access to all walls after the fact. You could choose not to install vents initially, with the knowledge that it may be required later).

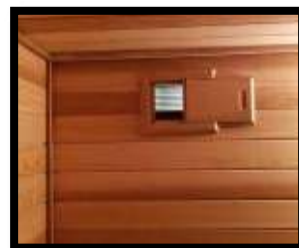

One outlet slide vent cover is included with kit.

Inlet vent is typically a series of holes drilled through cedar lining. The heater conceals the holes. (An optional cedar grill may be provided if ordered.) If there is gap under door and heater is close, the door gap can act as the inlet vent.

Exterior grill NOT included. Use painted aluminum (or other) to match exterior decor. Our outlet vent requires 4.5" x 4.5" opening. Most use spruce studs to box opening. Inlet area should be 19 square inches.

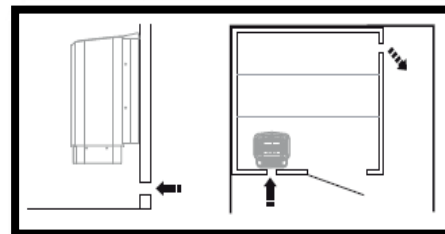

Sometimes, what is outside the sauna can limit the ability to easily install simple vents through the wall. In such cases, it may be possible to duct over drop ceiling and vent to an open indoor area.

IS VENT REQUIRED?

The short answer is: We cannot say for sure until sauna is operational. And at that point it may be not be possible to add. Our Rule of Thumb: If venting access is "now or never", now is better.

Poor ventilation can lead to:

- Insufficient heat at benches further from heater.
- Sauna heater integral high limit switch "tripping" because heat is trapped.

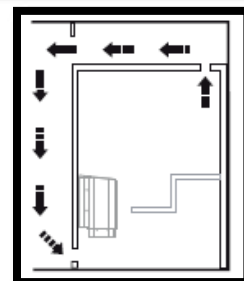

DOOR: (See pages #8)

See Your Material List to Verify "YOUR" Door selection and Rough Opening.

Frameless Glass door rough opening is 27-1/2" x 76-1/2" to finished floor.

Allows for the 74" jamb and the 1-1/2" spacer with gap to install below jamb threshold. (Door = 24" x 72")

Cedar Framed Insulated Glass door rough opening is 26" x 76-1/2" to finished floor. (Door = 24" x 74")

There is gap under door to allow for a back-up air inlet.

Jamb Extension: (see drawing #8a)

1x2 trim provided for jamb extension where required. Required with frameless glass doors and 11/16" lined kits.

WIRING:

See electrical wiring drawings packed with selected heater/control.

The Wiring Should Be Done Only By A Qualified Electrician.

Electrical rough-in wiring should be done at this time. Wire size and wire pathway is dependent on heater model and size.

If using an outside control (not built into the heater), the thermostat should be installed at this time. Install on the wall outside the sauna with the sensing bulb located as indicated in heater instruction manual.

Tylo Sport & Saaku: Supply wire to heater. Controls on heater. Sensor built into heater.

Tylo Plus or Combi with Pure or Elite control: Supply wire to heater.

Sensor from heater to 1" down from ceiling, 3" from the edge of the heater, (NOT in corner).

Note: Control cable is 15', from bottom of heater to control location. (50' available as option.)

Sauna Craft Controls: (TPT3 or EL13) 3-gang box provided with control for installation outside sauna. Controls are line voltage. Locate the sensing bulb 1" maximum down from the ceiling 1'-2' away from the heater.

For heaters up to 6kw, Supply wire goes first to control and then from control to heater.

For heaters 7.5 kw and larger there is a magnetic contactor and additional wires for the control circuit (field supplied)



Standard light fixture included is surface mounted marine light. **Wall mount recommended**

Requires octogen electrical box (not included)

Light has a separate 120-volt power supply. Light switch is not provided.

If you have Tylo with Plus or Elite control, you can direct 120v through heater and use control to operate light.

Optional recessed ceiling lights may be used in place of wall light

INSULATION

The walls and ceiling should be insulated in the with 3 1/2", R-12 fiberglass insulation.

Rockwool can be used as well.

FOIL BARRIER:

Install aluminum foil. Staple to the inside edge-face of studs over the insulation. Overlap the seams approximately 3". If paper backed, install with "shiny" side facing into the sauna.

DO NOT TAPE SEAMS. The foil is intended more as a heat reflector than vapor barrier. Taping seams can impede air flow. (If seams are taped, properly installed sauna vents are imperative.)



TONGUE & GROOVE LINING: (see drawing #1 & #5)
While not required, most choose to line the ceiling first.

Before you begin, examine all the pieces of tongue and groove cedar. You may find certain boards that you do not like, whether it is due to a knot or color. Make an effort to "hide" these boards. Install these boards behind benches or heater where they will not be visible.
Kit come with several extra pieces of t & g cedar at no additional charge.

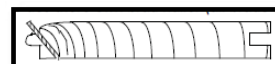

Use the specified lengths of tongue and groove cedar (see "Material Packing List"). Cedar generally comes 1/4" below the foot. You are expected to trim each board to fit. Nail through the tongue only in order to conceal all nail heads (Blind nailing - see drawing #5).



HORIZONTAL LINING: (see drawing #1)

The cedar wall pieces should be left about 1/2" off the floor. If a tile baseboard has been installed, you start above the base. Start at the floor and work your way up. Ensure the first board is level. Check the level every 4-6 boards. The first cedar piece should be installed with the tongue facing up. There is up to a 1/32" variation in width. Corners may not line up perfectly. Corner molding is supplied.

VERTICAL LINING: (see drawing #2)

The cedar wall pieces should be left about 1/2" off the floor. If a tile baseboard has been installed, you can start above the base or overlap it. Corner molding is supplied.

EXTERIOR:

NOT included unless ordered as option. For exterior walls: drywall or paneling may be used to match your decor.

BENCHES: (See Drawings #9-#13 for bench assembly details).

Clear cedar 2" x 4" boards for the bench TOPS (and floor supports where required).
Bench GIRTHS (sleepers) are knotty

BEFORE DOING ANY FASTENING, select the boards to make sure the BETTER side of the board comes out on the sitting surface. While you build the benches, the better side will be faced down because you are fastening from the bottom. (That way you do not get any screws showing up on finished surface.) Use the 2-1/2" screws supplied. (See Drawings #9 to #13 for bench assembly.)

If the sauna is 5' or more deep, the top bench is 20" wide (5 boards + eased edge) and bottom bench is 16" wide (4 boards + eased edge). If the sauna is under 5' deep, make the bottom bench 8".

BENCH SUPPORTS: (for 2x4 bench tops)

Bench cleats are 2x4 with cut corner; girths are 2x4 (square) (see drawing #1, #10 & #12).
Cleats are clear cedar. Girths may be Knotty Cedar.

Bench girths and cleats are provided as follows:

20" deep bench Cleat/Girth = 18"

16" deep bench Cleat/Girth = 14"

(For 12" deep bench, cut down to 10") (For 8" deep bench, cut down to 6")



BENCH GIRTHS: (drawing #10) (Knotty Cedar) Girths screwed from bottom of bench

Up to 6' long --4 Girths

7' + longer --5 Girths

Benches over 6' & "L" benches have center floor support.



BENCH CLEATS: (drawing #12) Bench cleats are screw through cedar into spruce stud support 2-1/2" screws provided.

Top bench - Use the 18" bench cleats (cut down if bench to be narrower than 20").
Mount 33" from the floor to top of the cleats, tight to the back wall. If the bench is 7' or longer, install a center floor support.



Bottom bench - use the 14" bench cleats (cut down if bench is narrower than 16").
Mount 15" from the floor to the top of the cleat, 20-1/4" from the back wall (drawings #1 & #3). If the bench is 7' or longer, install a centre floor support.

"L" SHAPED RETURN BENCH: (drawing #13)

Where there is only a single tier, L"- shaped return bench along the side wall, it is typically installed as a top bench. For an "L"- bench, the bench supports should be installed as follows:
Use an 18" cleat where the bench meets the (front) sauna wall. Fasten the other cleat to the face of the back wall bench at the same height off the floor. Material is provided to build a floor support. Install floor support in front of the main bench.



HEATER:

Sauna Craft heaters (up to 9kw) can be mounted in the corner or on a straight wall. Generally, the least amount of space is occupied by mounting the heater on the wall, 2" from the corner.

Tylo and Saaku heaters can only be mounted on a straight wall.



GUARD RAIL: (See drawing #14)

Use the 2x2 for the vertical posts and the 1x3 for the horizontal rails.

Tylo Heaters have a cool-touch shell & some choose not install guard. However, a guard is provided for you and it is recommended that you install it.



METAL FASTENERS

Nails are galvanized. Screws are treated.

FLOOR: (option) (See drawing #15)

Use 1x4 cedar, square edge laid over 1x4 knotty cedar sleepers. Top boards should be spaced 1/2" apart. The sleepers should be placed at 1'-0" on centre.



BACKREST & BENCH SKIRT: (See drawing #16) (LK Plus option. Included with LK Premium)

HOW TO TAKE A SAUNA

1. Start with a brief shower using warm water and soap. Rinse thoroughly. Do not towel dry.
2. Enter the pre-heated sauna - 80°-90° C. (176°-194° F) Relax and allow your body to perspire freely in the soft dry heat. Do not throw water on the rocks in this first session. Do not expect to begin and finish your sauna in a few minutes. Even in the extreme heat of a sauna, it takes time for your body temperature to rise and for you to begin to perspire freely.
3. Cool off with a cold shower.
4. How long you stay in the sauna is up to you. It depends on your comfort level. It is not an endurance test. People often start at 5–10 minute intervals and work up to longer periods.
5. Re-enter the sauna. Sprinkle water on the hot rocks to bring up a little steam and increase the humidity. This will increase the feeling of heat and assist the perspiration process. If you like add a few drops of scented essence such as eucalyptus into the water you splash on the rocks. It will disperse throughout the sauna.
6. Take a cold shower. Repeat the sauna/cold water cycle as often as you desire.
7. Dry yourself completely. Then sit or lie down, letting your body relax.
8. Dress and have a light sauna snack.

NOTE: When used for the first time, you will notice smoke coming off the heater elements. This is normal. Leave the door open and allow the sauna to run about 20 minutes.

For additional information:

SAUNAFIN SAUNA & STEAM
115 Bowes Road, Unit #2,
Concord, Ontario L4K 1H7
Phone: (905) 738-4017

HORIZONTAL LINING IS STANDARD. CHECK YOUR MATERIAL LIST TO VERIFY YOUR LINING

#1

SIDE VIEW CROSS SECTION (FOR SAUNAS LINED HORIZONTALLY) (NOT TO SCALE)

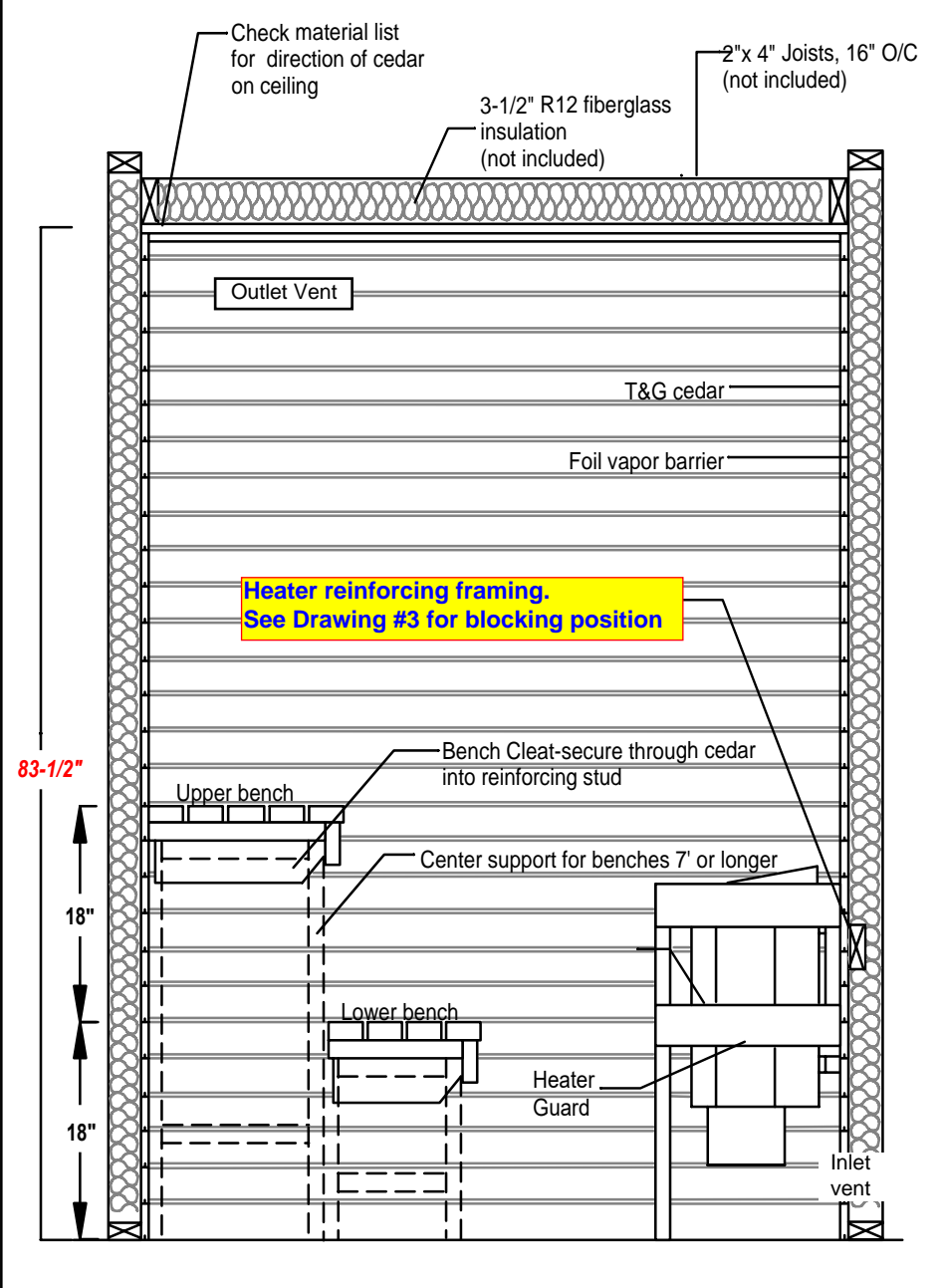

TOP VIEW CROSS SECTION (FOR SAUNAS LINED HORIZONTALLY) (NOT TO SCALE)

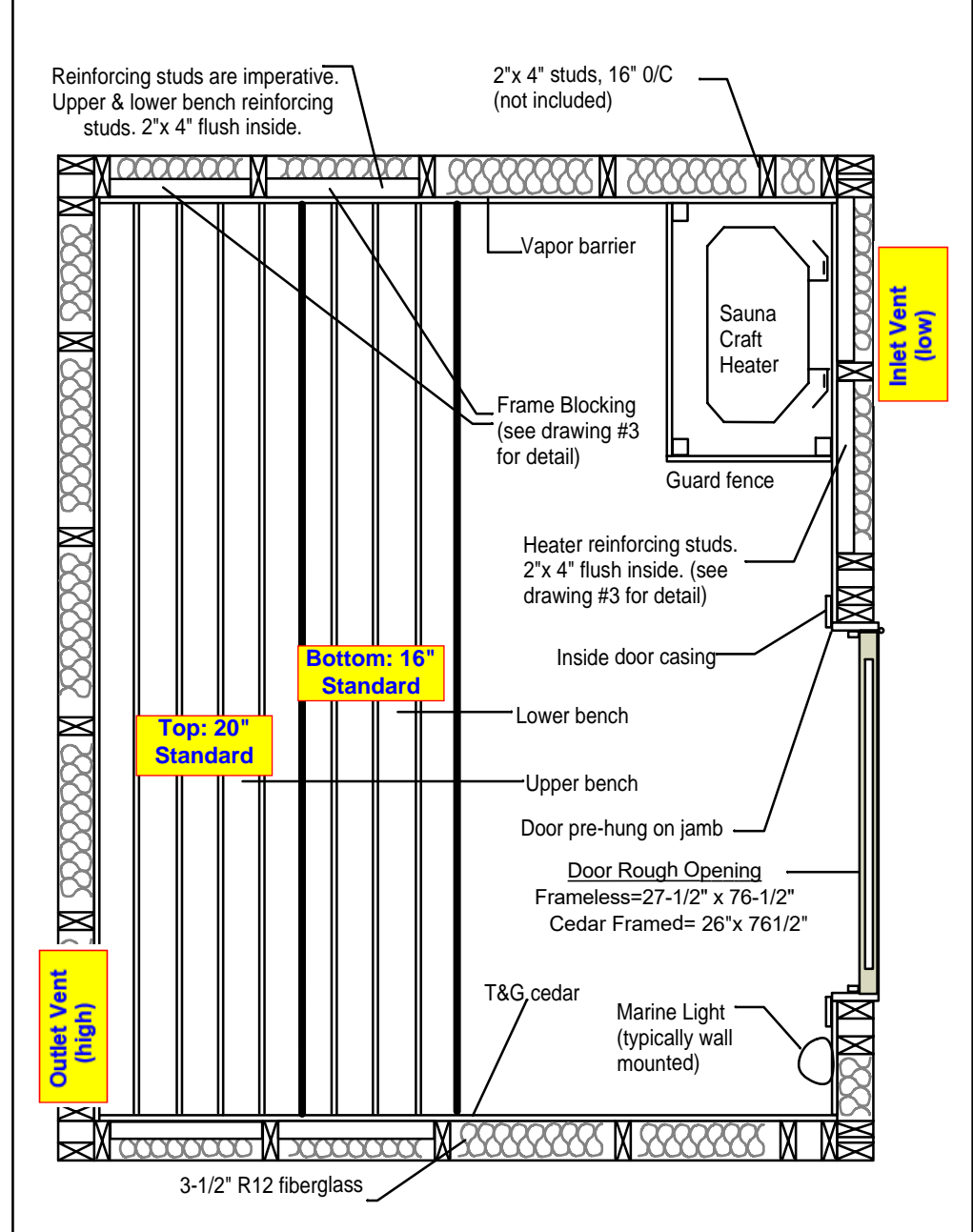

NOTE: This drawing shows standard sizes & dimensions. It may not reflect your exact sauna. Check your Material List for specifics for your sauna

VERTICAL LINING WHERE SPECIFIED. CHECK YOUR MATERIAL LIST TO VERIFY YOUR LINING

#2

**SIDE VIEW CROSS SECTION
(FOR SAUNAS LINED VERTICALLY) (NOT TO SCALE)**

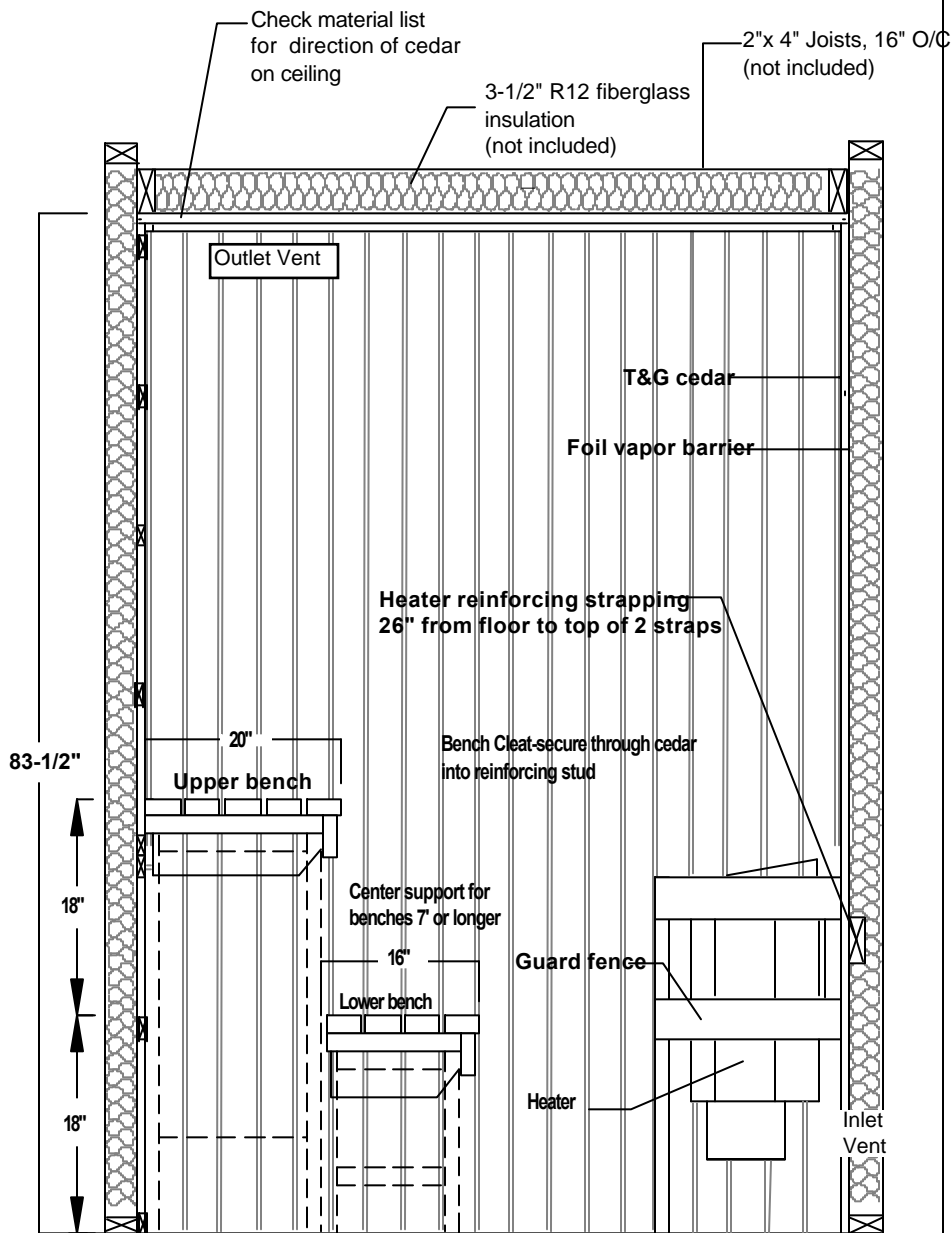

**TOP VIEW CROSS SECTION
(FOR SAUNAS LINED VERTICALLY) (NOT TO SCALE)**

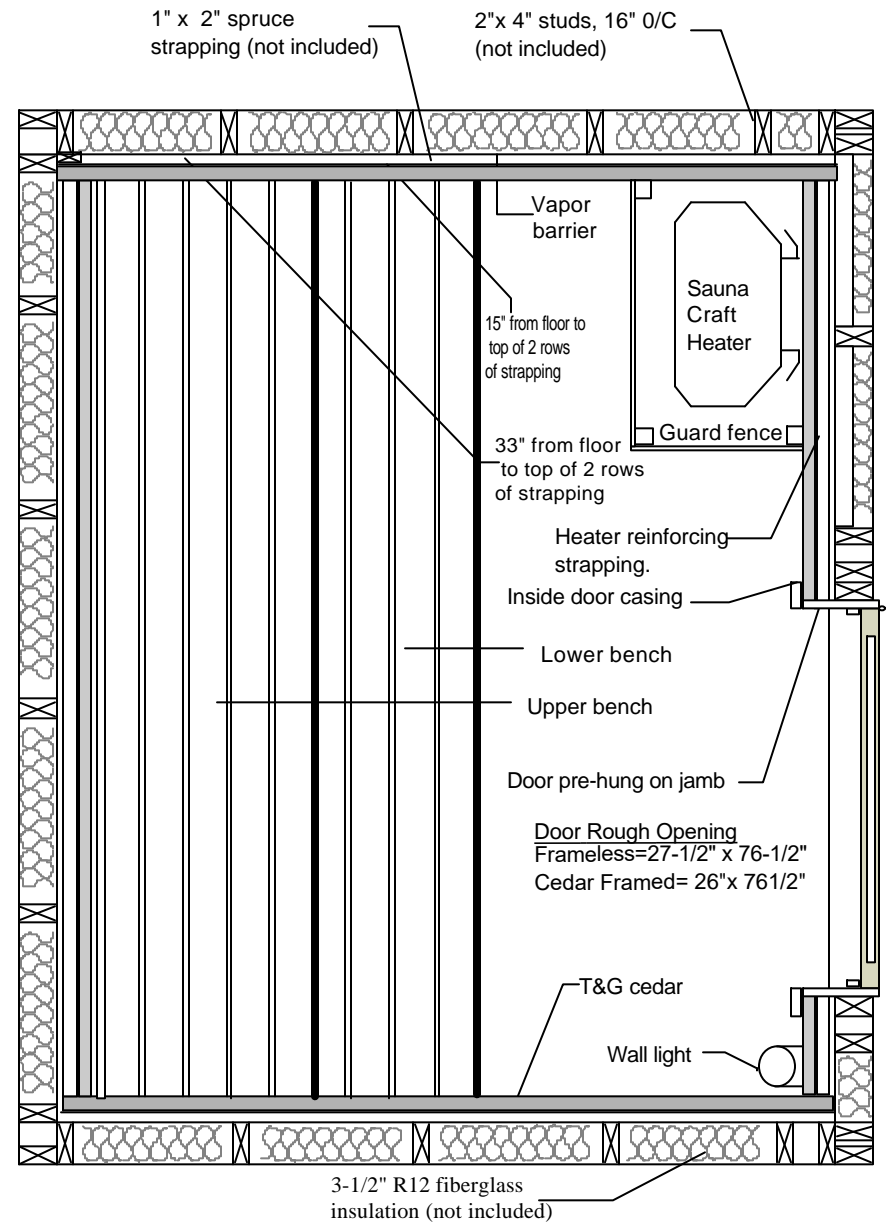

NOTE: This drawing is generic and does not necessarily reflect your exact sauna. Check your Sauna Material List for specifics on you sauna.

#3

REINFORCING STUDS for 2x4 BENCHES and HEATERS

Bench Blocking

2x4 Spruce
Studs @ 16" O.C.

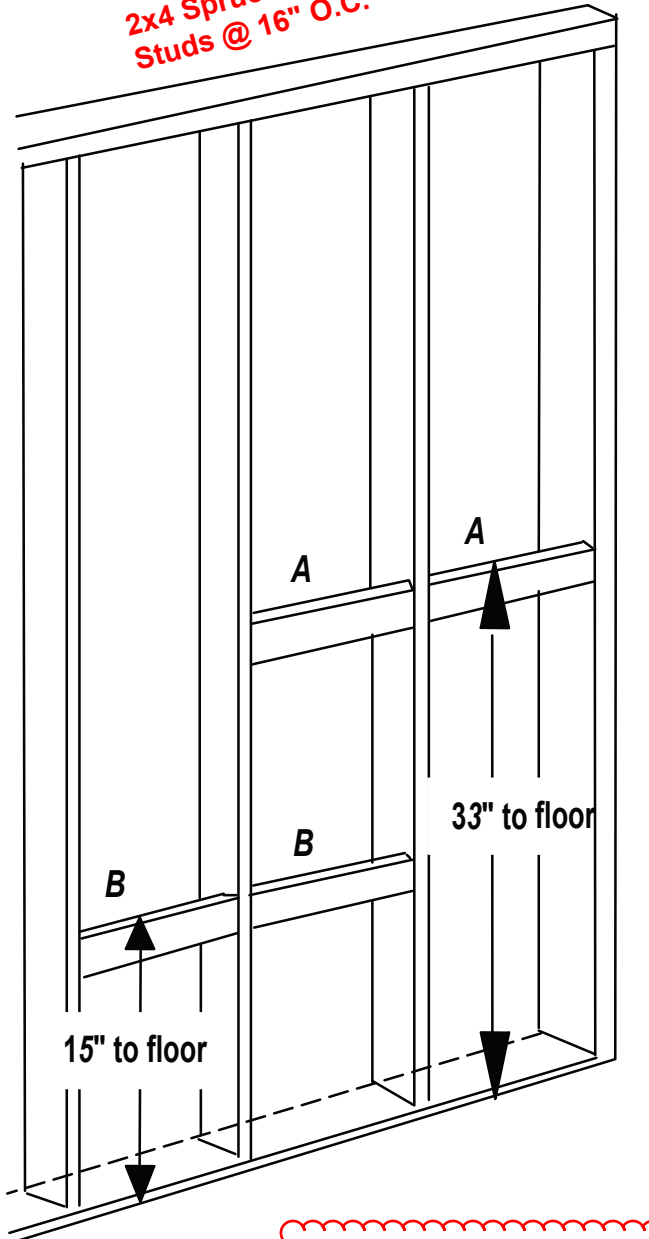

A = Top bench blocking. 33" from floor to top edge of blocking
B = Bottom bench blocking. 15" from floor to top edge of blocking.

#4

REINFORCING STUDS for HEATERS

Sauna Craft

(Add blocking on adjoining wall if heater to become mounted)

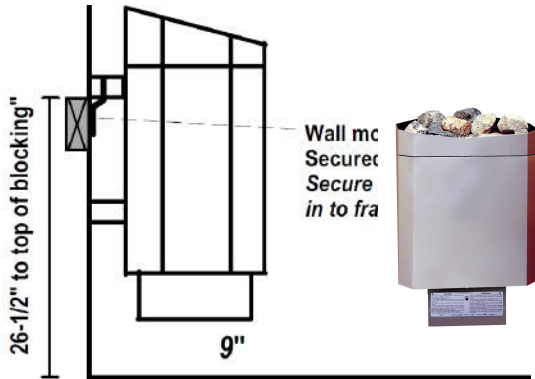
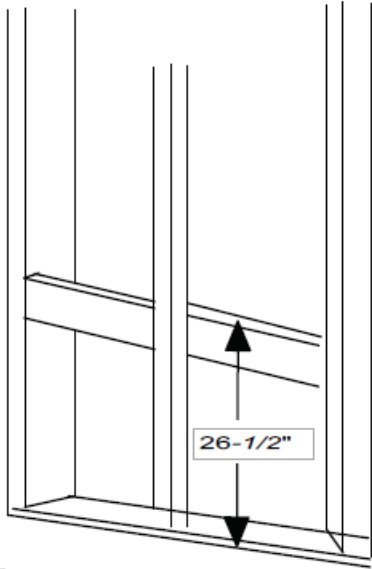

Tylo

From top of 2x4 blocking to the floor

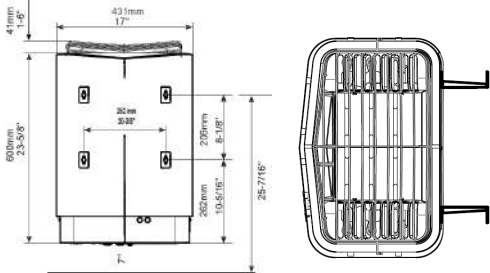
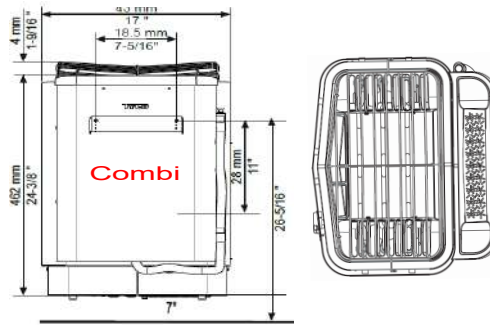
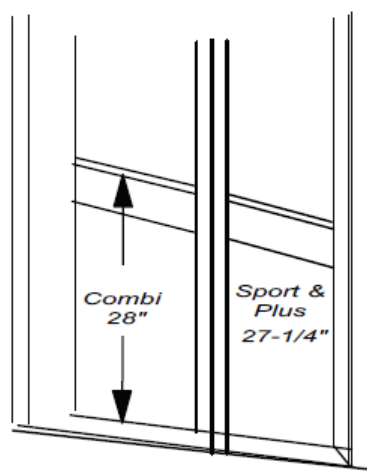

Sport & Plus

Saaku.

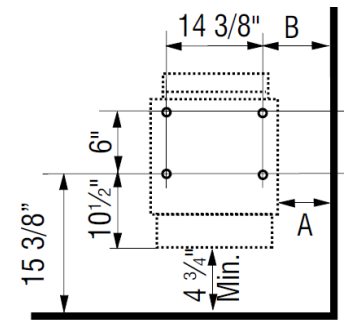
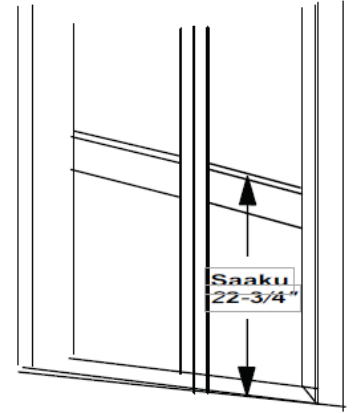

#5

Tounge & Groove Hidden Nailing

1-1/4" galvanized finishing nails for lining (supplied)

Many prefer to use their own brad nail gun.

Nail through tongue. And hide inside groove.

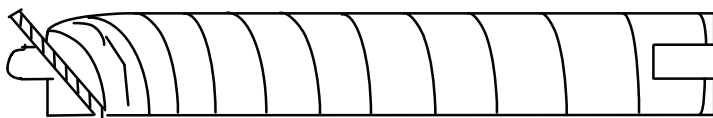

A NOTE ON VENTING:

In many cases a vent is not required for normal sauna function. If you have access to vent walls after the fact, you may elect to forgo vents with the knowledge that they could be added at a later date.

If you do not have access after the fact, it is more of a "now or never" scenario. In this case we recommend you install the cross ventilation. If wall inaccessible (i.e. exterior wall), you can look at options of venting over the ceiling and ducting to open area. We do not recommend venting to the outdoors

OUTLET located high on wall diagonal from inlet

Cedar slide vent on sauna side.

Exterior has aluminum grill (not included) to match exterior decor.



Fixed cedar grill:
Optional with LK Plus
Incl with LK Premium

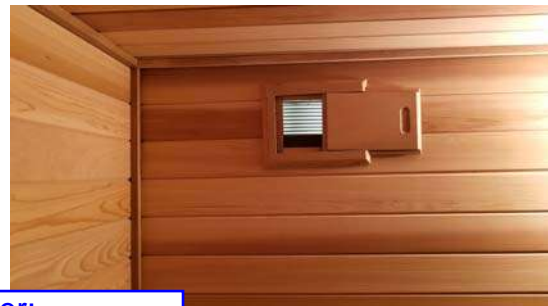
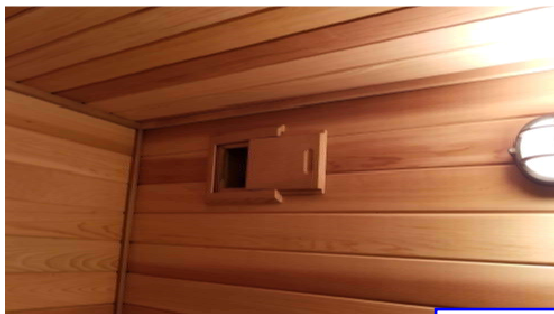

Slide Vent Cover:
One included with every kit



Exterior Grill:
Not Included
Select to match you decor

Slide Vent Cover

If outlet is exterior wall, you must run duct or construct a chase through stud cavity and over drop ceiling. Exhaust into room in front of sauna.

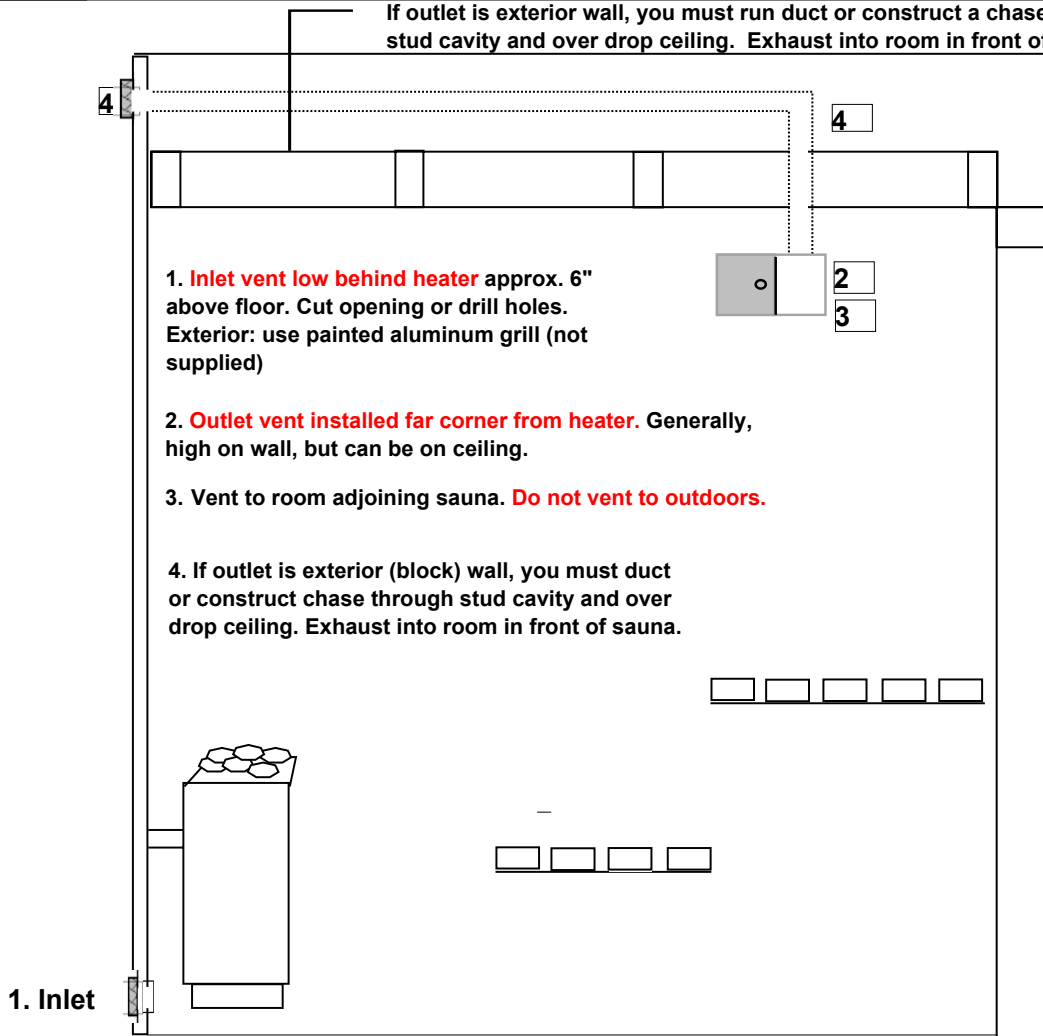

1. **Inlet vent low behind heater** approx. 6" above floor. Cut opening or drill holes. Exterior: use painted aluminum grill (not supplied)
2. **Outlet vent installed far corner from heater.** Generally, high on wall, but can be on ceiling.
3. Vent to room adjoining sauna. **Do not vent to outdoors.**
4. If outlet is exterior (block) wall, you must duct or construct chase through stud cavity and over drop ceiling. Exhaust into room in front of sauna.

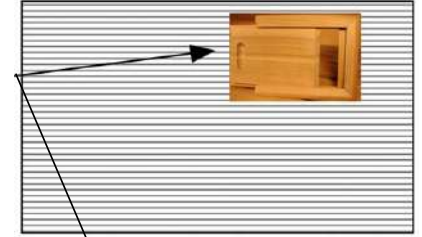

Slide Vent:
Vent when open = 7" x 13"
Wall opening = 4.5" x 4.5"

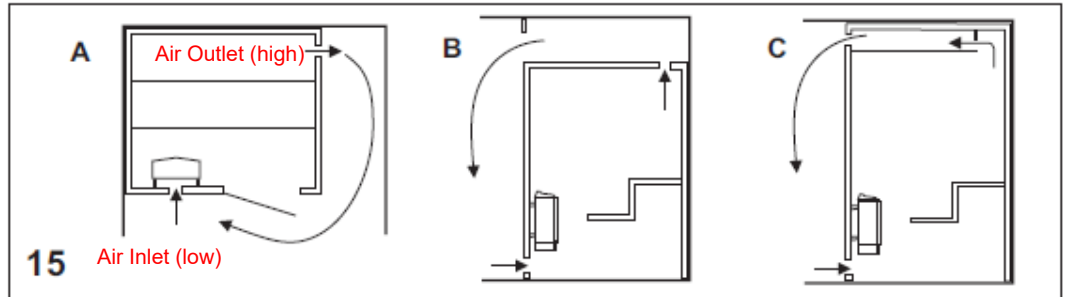
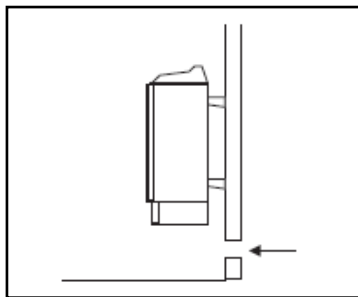
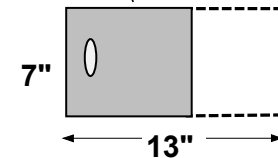

The inlet vent should be driven straight through the wall directly below the center of the heater. The cross-section of the vent for a wall mounted sauna is approx. 19 sq.in. For larger saunas approx. 40 sq.in

Position the air inlet and outlet vents as far away from one another as possible (diagonally opposite). The outlet vent should be located high on a wall or in the ceiling, and should have the same cross-section area as the inlet vent. Spent air should always be led back into house – it should not be discharged directly to the outside. Do not install inlet and outlet vents on same wall. Bad ventilation can be worse than no ventilation.

A: Outlet vent through the sauna wall (seen from above). The vent is placed high up, near the ceiling.

B: Outlet vent through the cavity above the sauna ceiling (seen from the side).

C: Outlet vent through a drum under the ceiling in the sauna (seen from the side). The outlet duct should be placed at an angle between the ceiling and the wall. The drum can be built of wooden panelling and have the same area as the outlet vent.

Inlet: If drilling holes for inlet, must equal specified sq inch requirement. Six 2" or eight 1.75" holes are sufficient.

#8

SAUNA DOORS

NOTE: Rough Opening means above "finished" floor; i.e. above tile

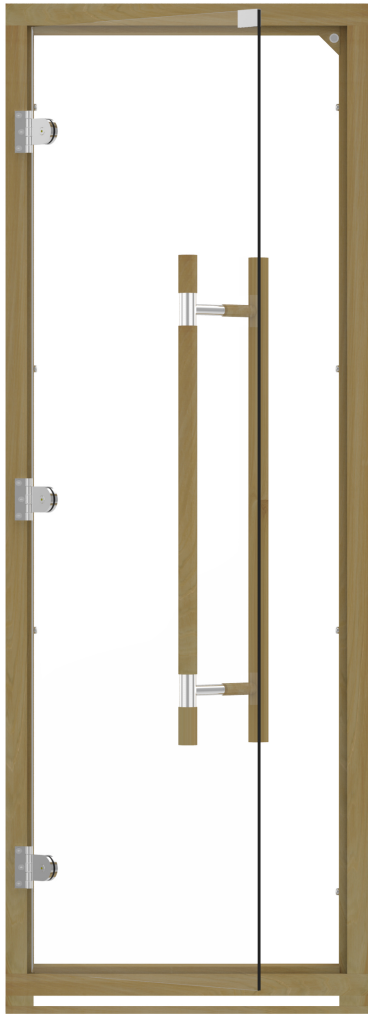

Frameless

R/O=27-1/2" x 76-1/2
incl bottom spacer with gap

(Hinge is reversible)



Cedar Framed Insulated Glass

R/O=26" x 76-1/2 gap under door (non-reversible)

NOTE: Gap or spacer can be deleted if you have effective cross ventilation as detailed in manual



Trim/Double Header

If you don't use frameless door bottom spacer, or door is shorter than R/O for another reason, you can "double case" header



Tips

If you don't want to see screws on jamb, you can screw behind stops

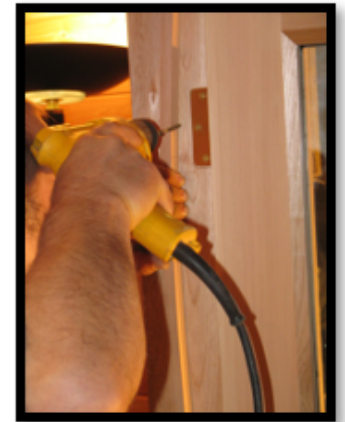

After installing door, replace center screw on each hinge with longer screws provided with kit



NOTE: We do provide instructions for how to hang a door. That is not something unique to saunas. We assume installer is familiar with how to shim, square and secure a door in place. If not there are numerous YouTube video demonstrations.

Jamb Extension Detail

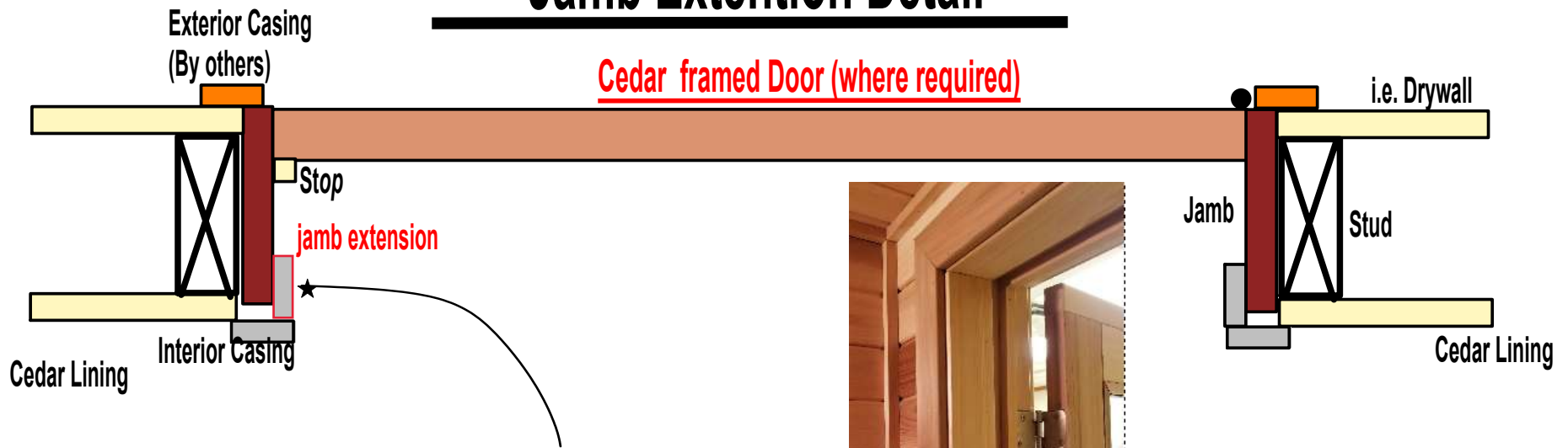

Where stud wall is thicker than standard; i.e 2x6 studs, a 1x2 for jamb extension.
 Secure jamb extension to jamb so that it extends flush with inside cedar lining of sauna.
 Install inside casing to conceal the gap at the jamb.

Exterior finish & Casing (By others)

Frameless Glass Door

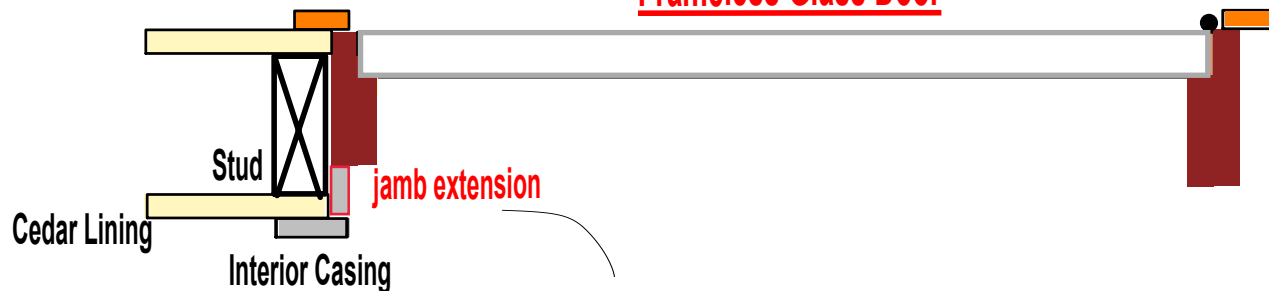

*For Frameless door jamb, nail jamb extension to stud.
 Trim so its flush to inside cedar lining.
 Use 1x2 jamb extension. Trim as needed*



#9

BENCH TOPS

Standard Top Bench=20"

Standard depth bench included for saunas 5' or deeper. For saunas under 5' bottom bench will typically be 8". See material list to confirm your sauna bench layout.

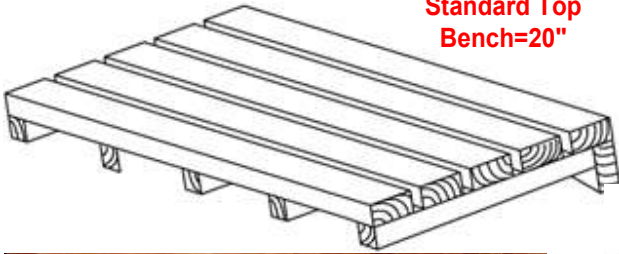

Standard Bottom Bench=16"

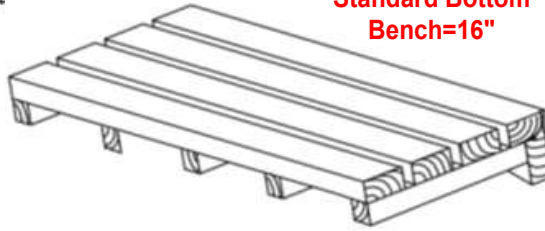

8" lower bench where space is limited



#10

BENCH GIRTHS



Tip: Use offcut cedar or framing scraps to make spacers for gaps when assembling benches. Approx. 9/16" gap between boards.

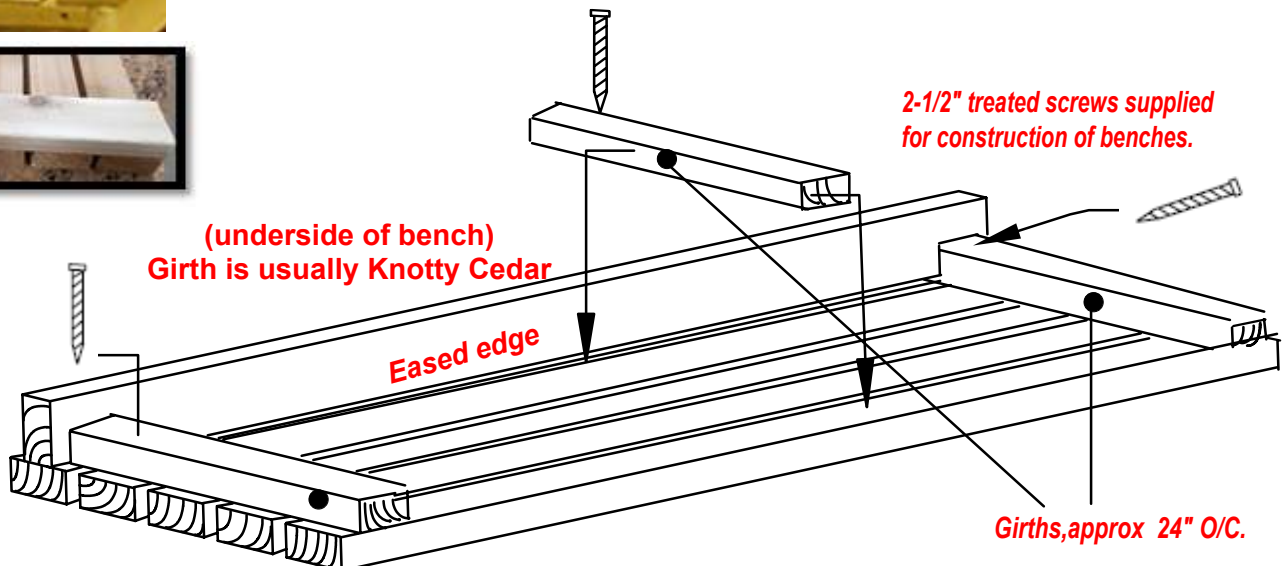

#11

CENTER FLOOR SUPPORT FOR BENCHES 7' OR LONGER

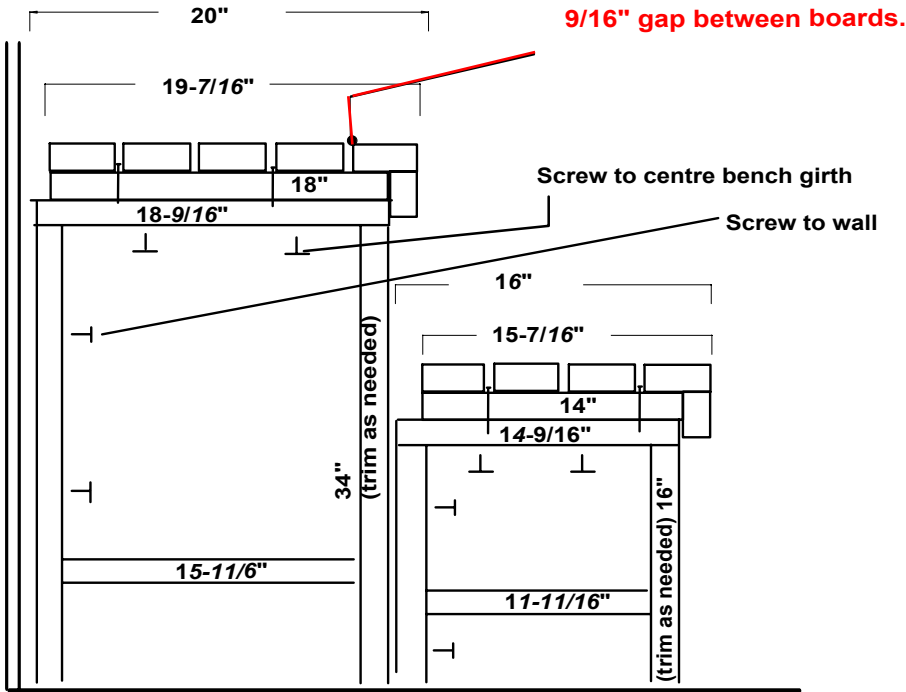

#12

BENCH CLEAT (wall hangers)

2 x 4 with Cut Corner Screw through cedar lining into blocking)



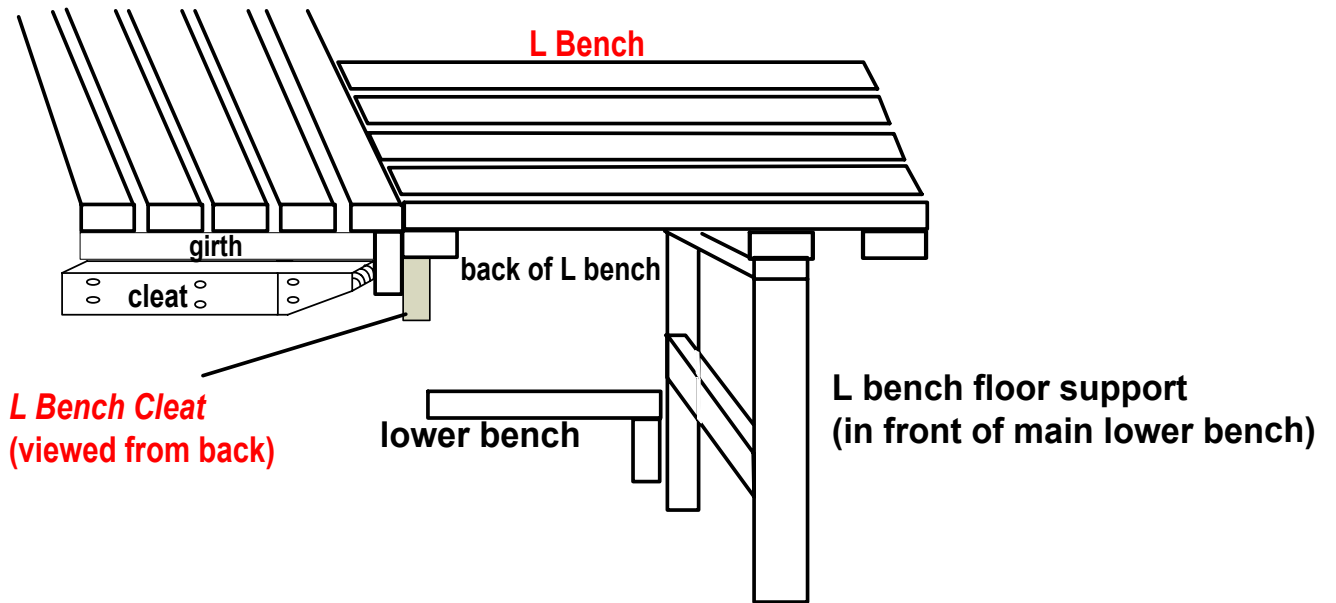
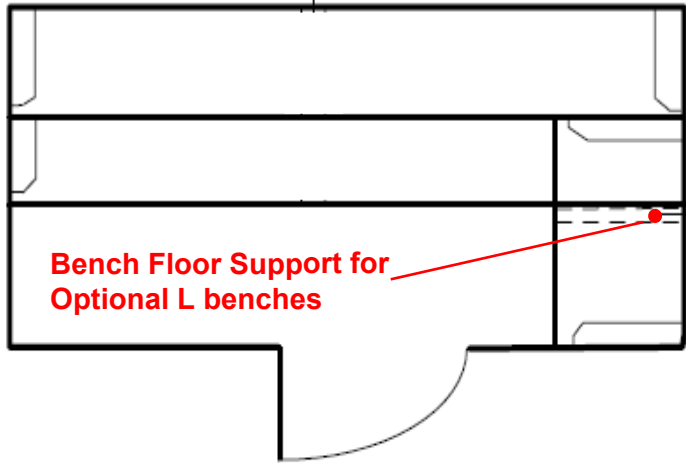

Bench Cleat screwed to face of main bench.

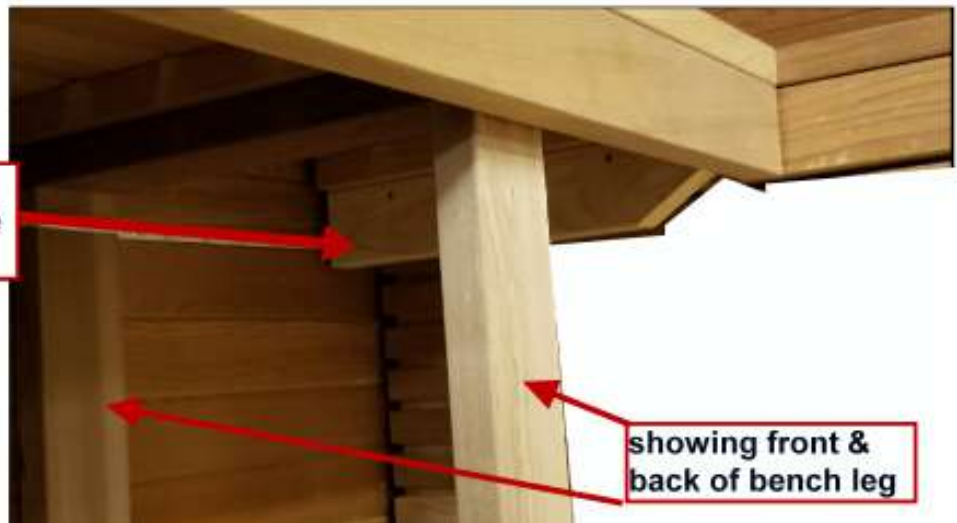

#14

STANDARD HEATER GUARD FENCE

Heater Guard: two sided, three sided or high sided as required

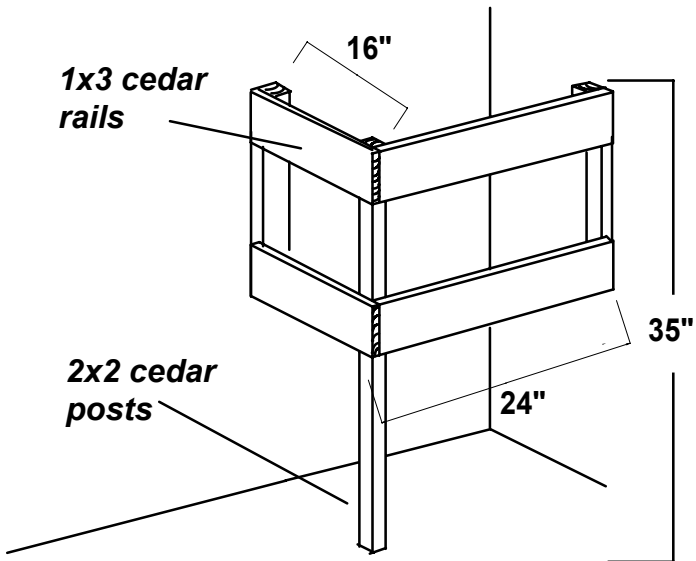

#15

**OPTIONAL 1" x 4" DUCKBOARD FLOOR
(where ordered)**

1x4 cedar tops
- 1/2" to 5/8" spacing

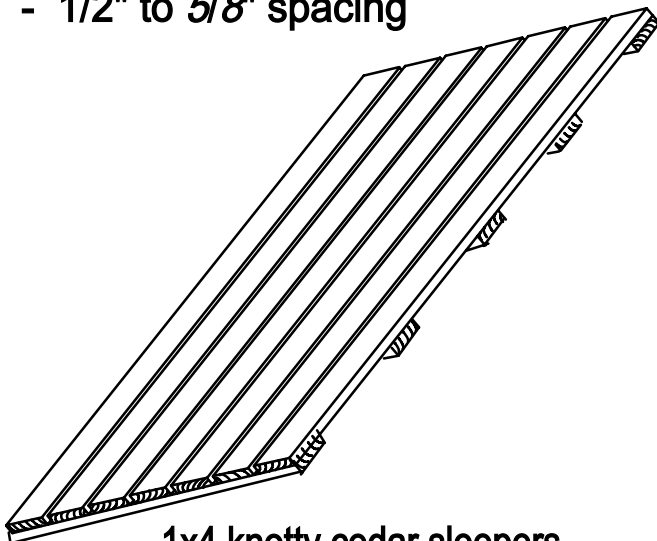

DESIGNER BACKREST & SKIRT

(Included with all LK Premium kits and LK Plus where added as option)

Bench Skirt (top riser)

1x2 s4s cedar tops (1x3 may be substituted).
 1x4 x 12" s4s cedar sleepers
 Assemble skirt from back, so nicer surface is facing front .
 Nail using 1" nails with heads provided
 Approx. 1/2" gap between bench tops for 12" height.
 Sleepers approx. every 2'.
 Install 2x2 cedar blocks to side wall at each end flush with bench floor support.
 Secure skirt to centre bench support and end posts

Tip: Nailing skirt looks nicer. Screws are more visible
 Screw if you want skirt to be removable

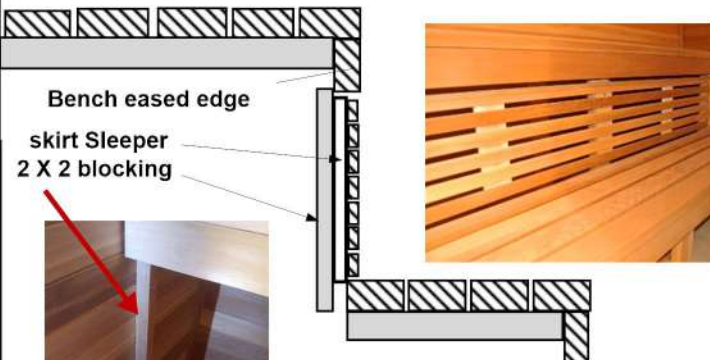
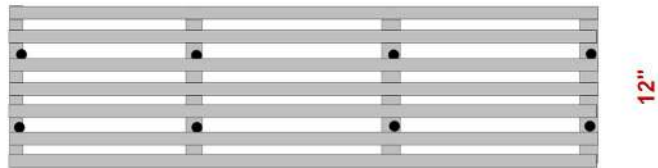
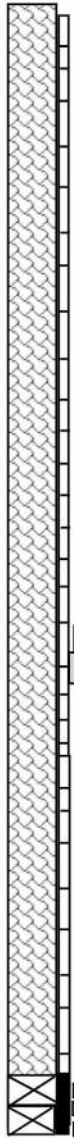

DESIGNER BACKREST



Walls and backrest all from Clear cedar
 Color variation is normal and expected with cedar



1x4 & 1x2 s4s cedar tops.
 1x4 x 12" s4s cedar sleepers
 Assemble backrest from back, so nicer surface is facing front .
 Nail using 1" nails with heads provided
 Approx. 5/8" gap between bench tops for 12" height.
 Sleepers approx. every 2'.

Tip: Nailing backrest to wall looks nicer.
 Screws are more visible