

Air outlet (high)

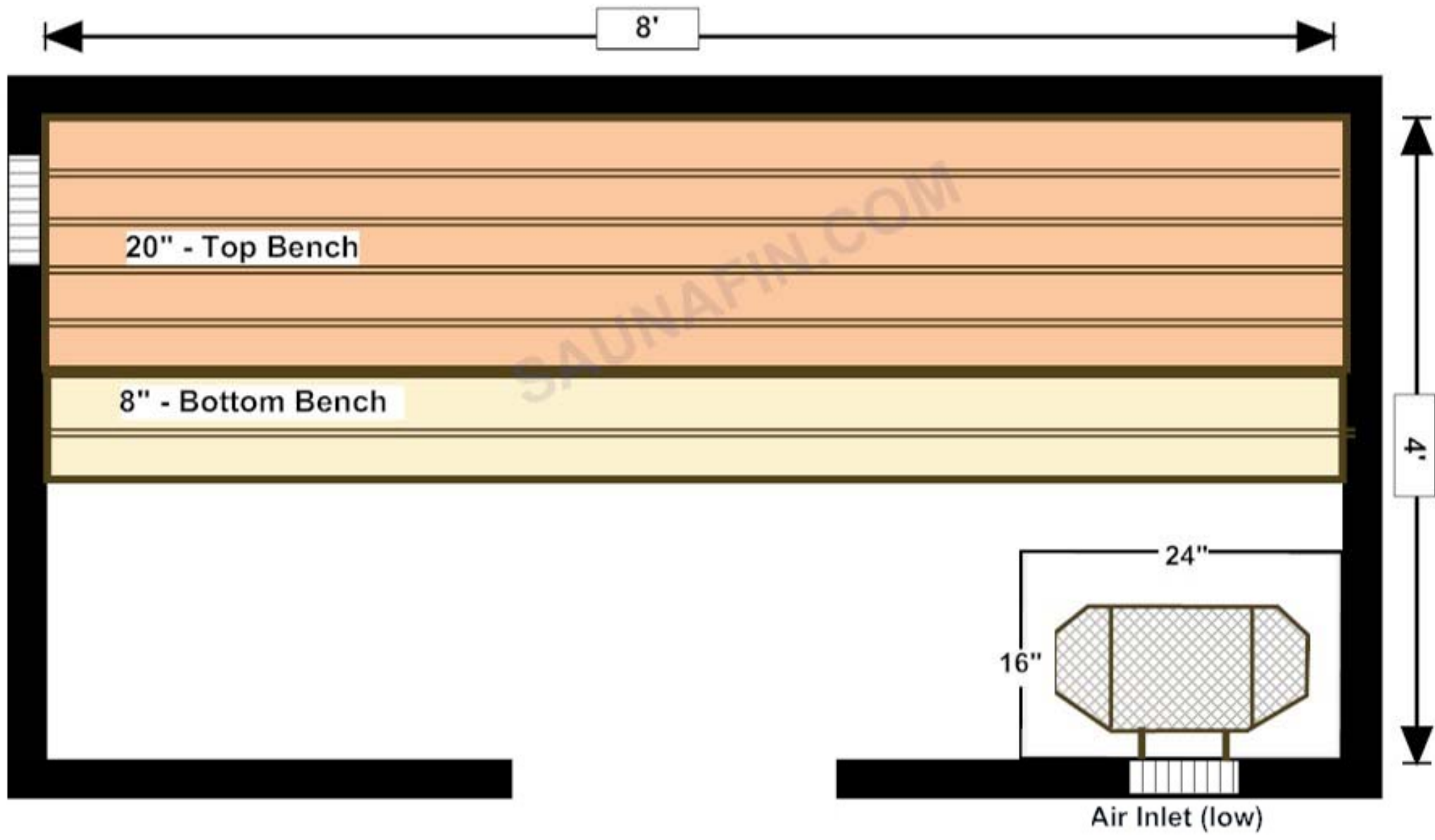

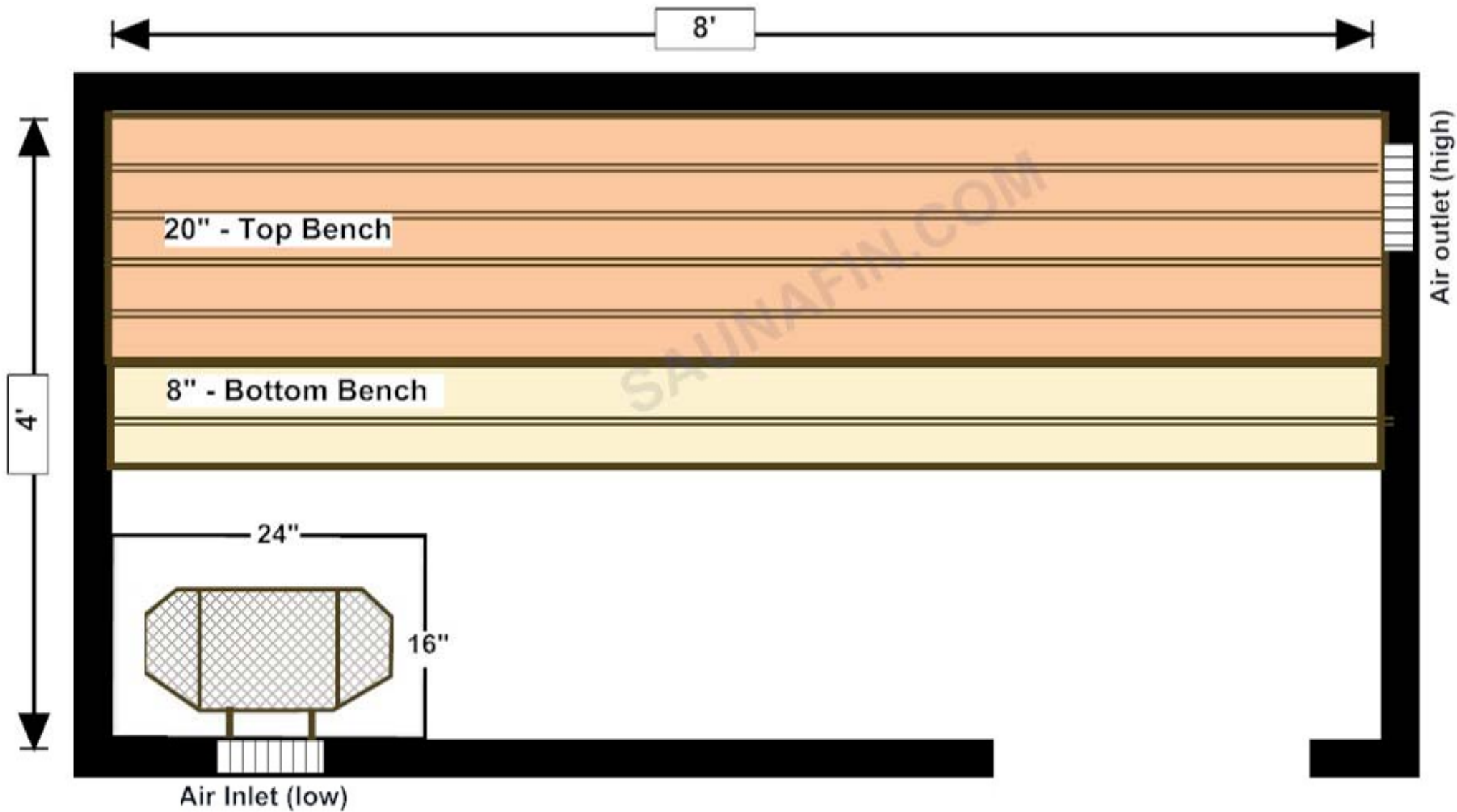

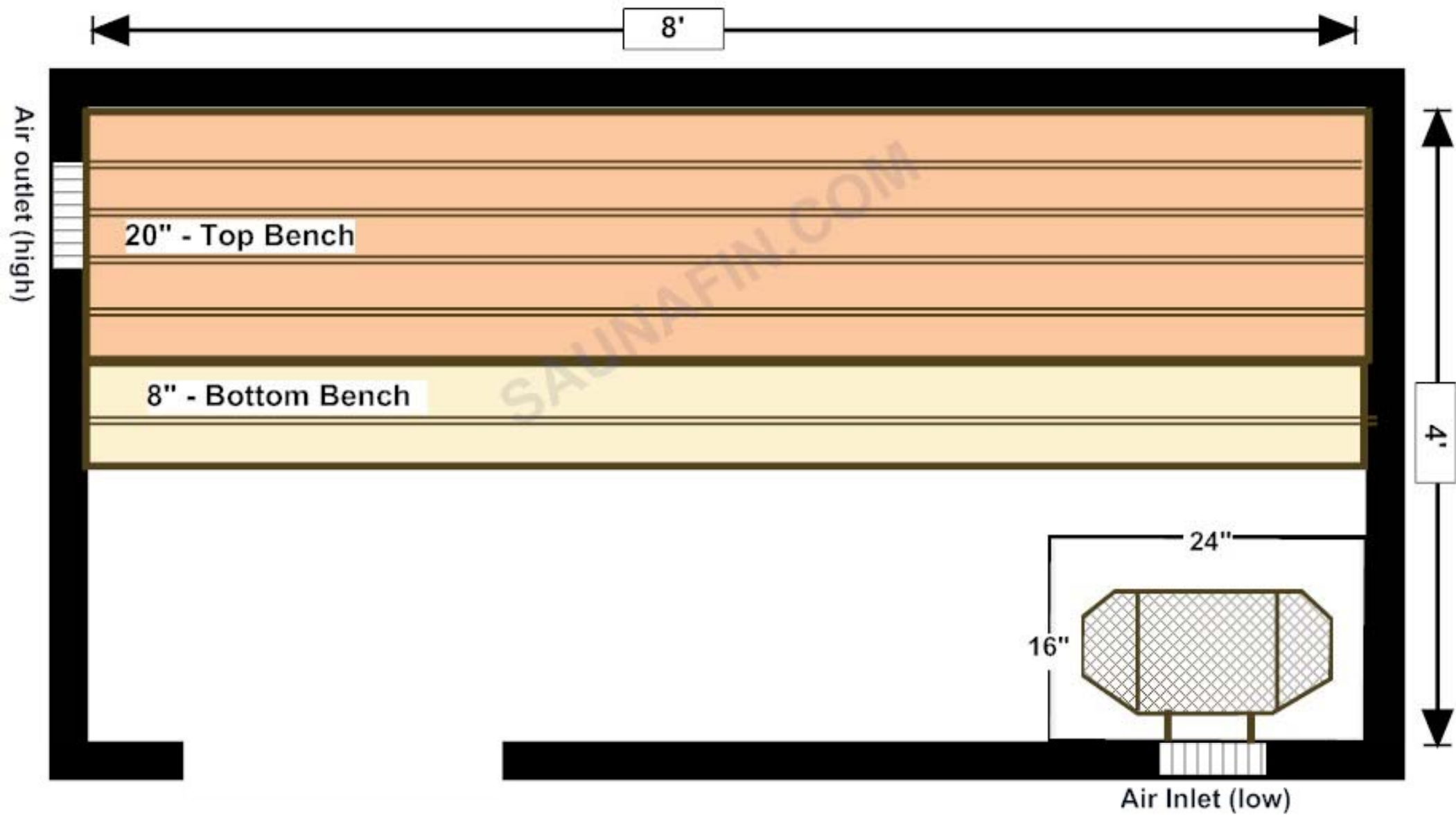

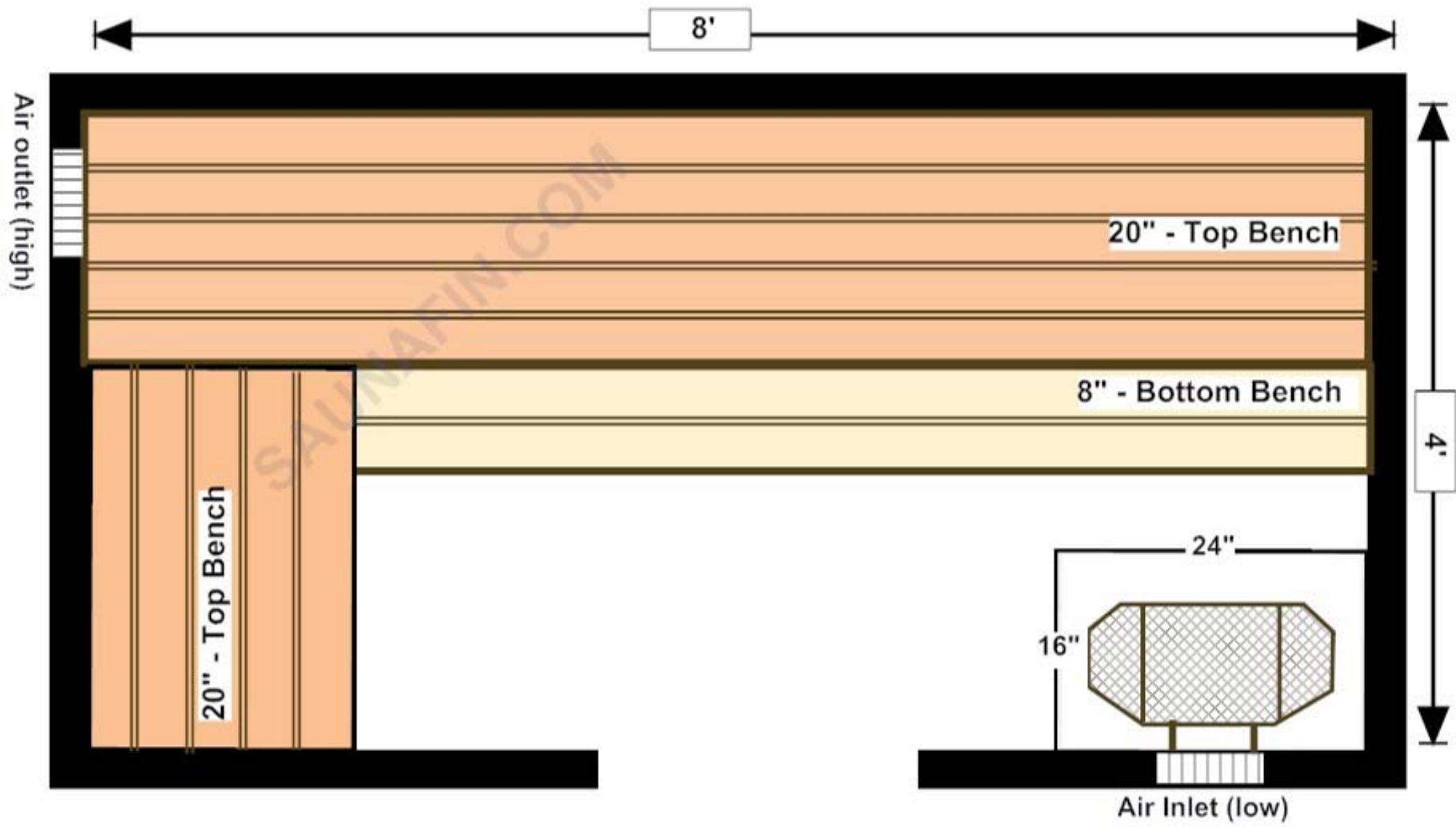

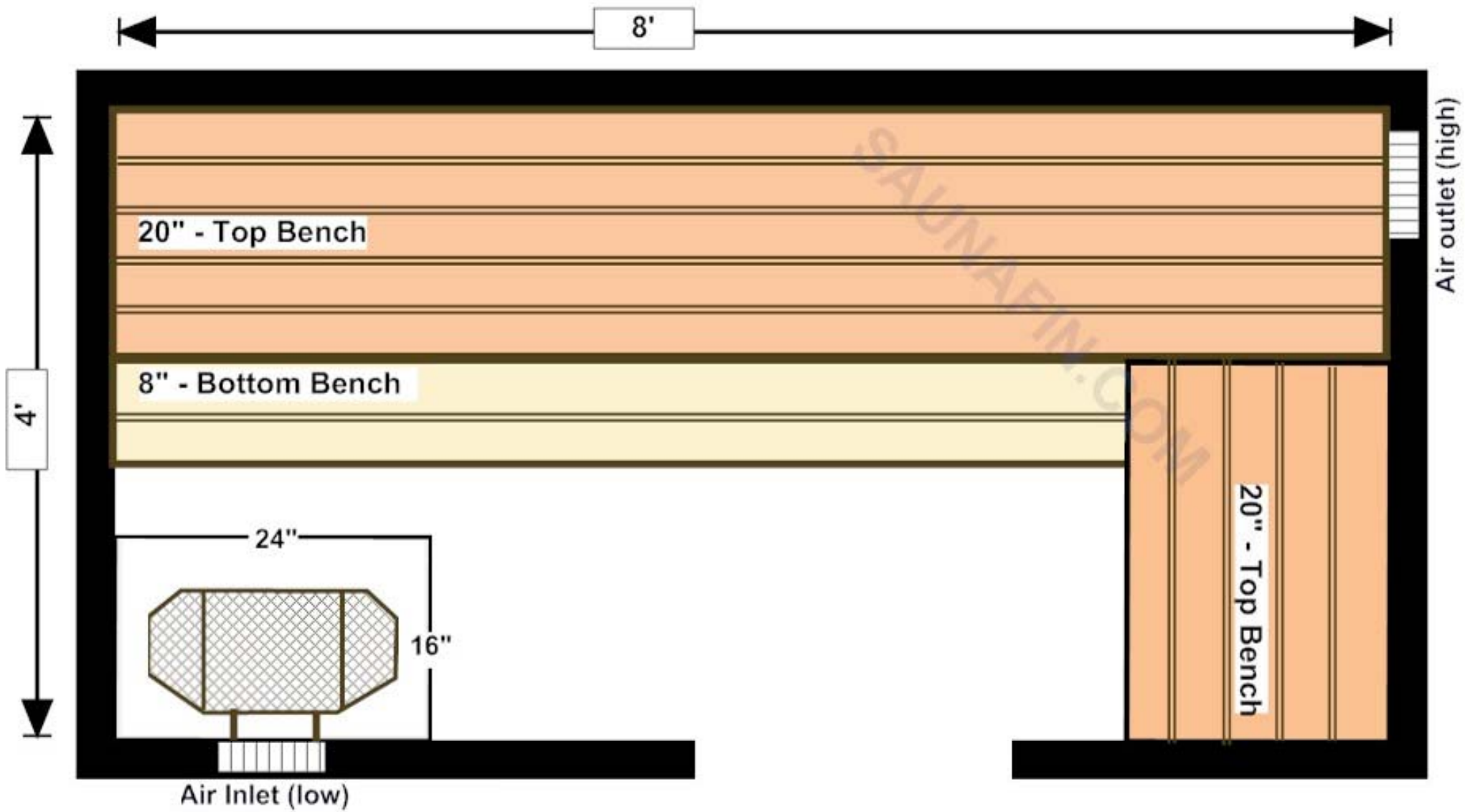

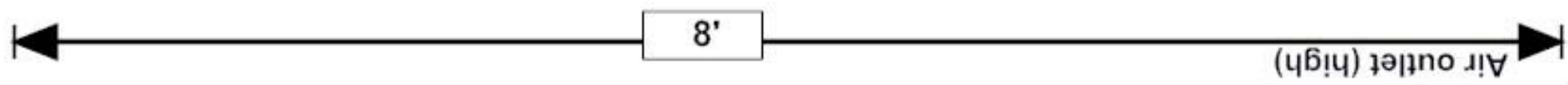

8'

Air outlet (high)

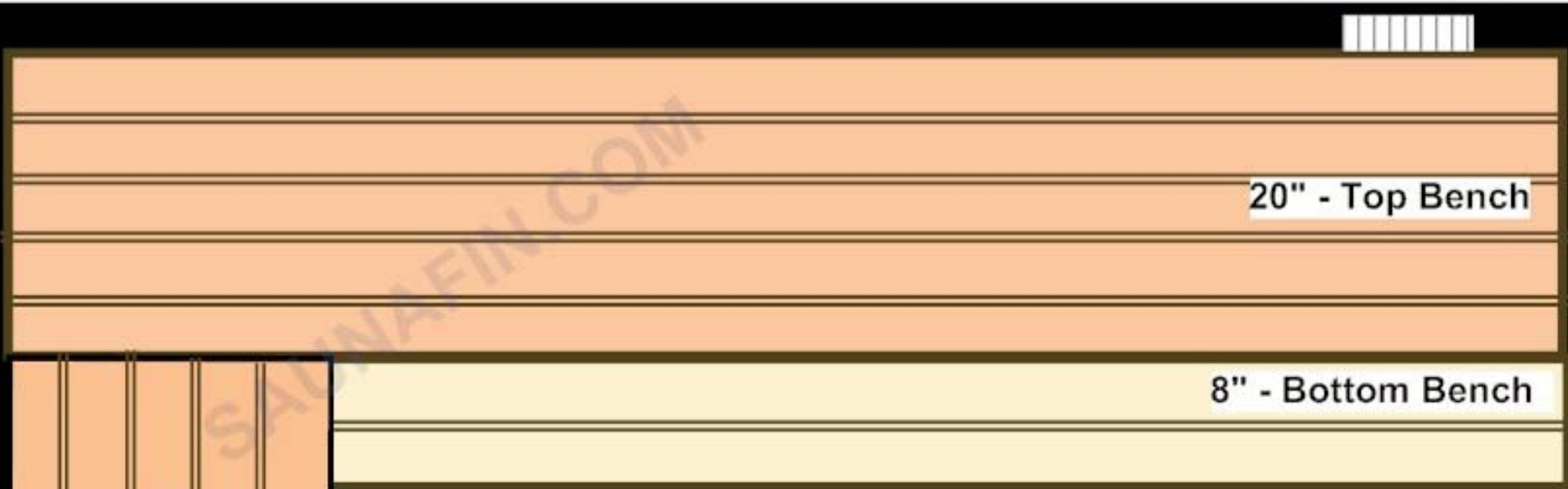

20" - Top Bench

8" - Bottom Bench

20" - Top Bench



4'

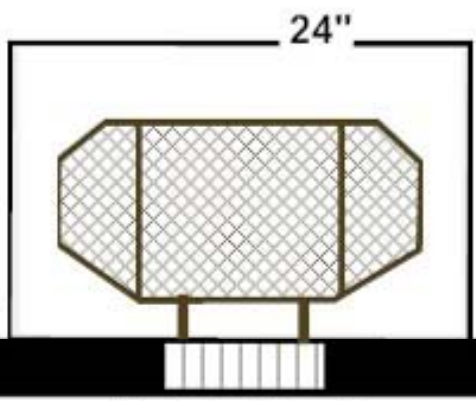

24"

16"

Air Inlet (low)

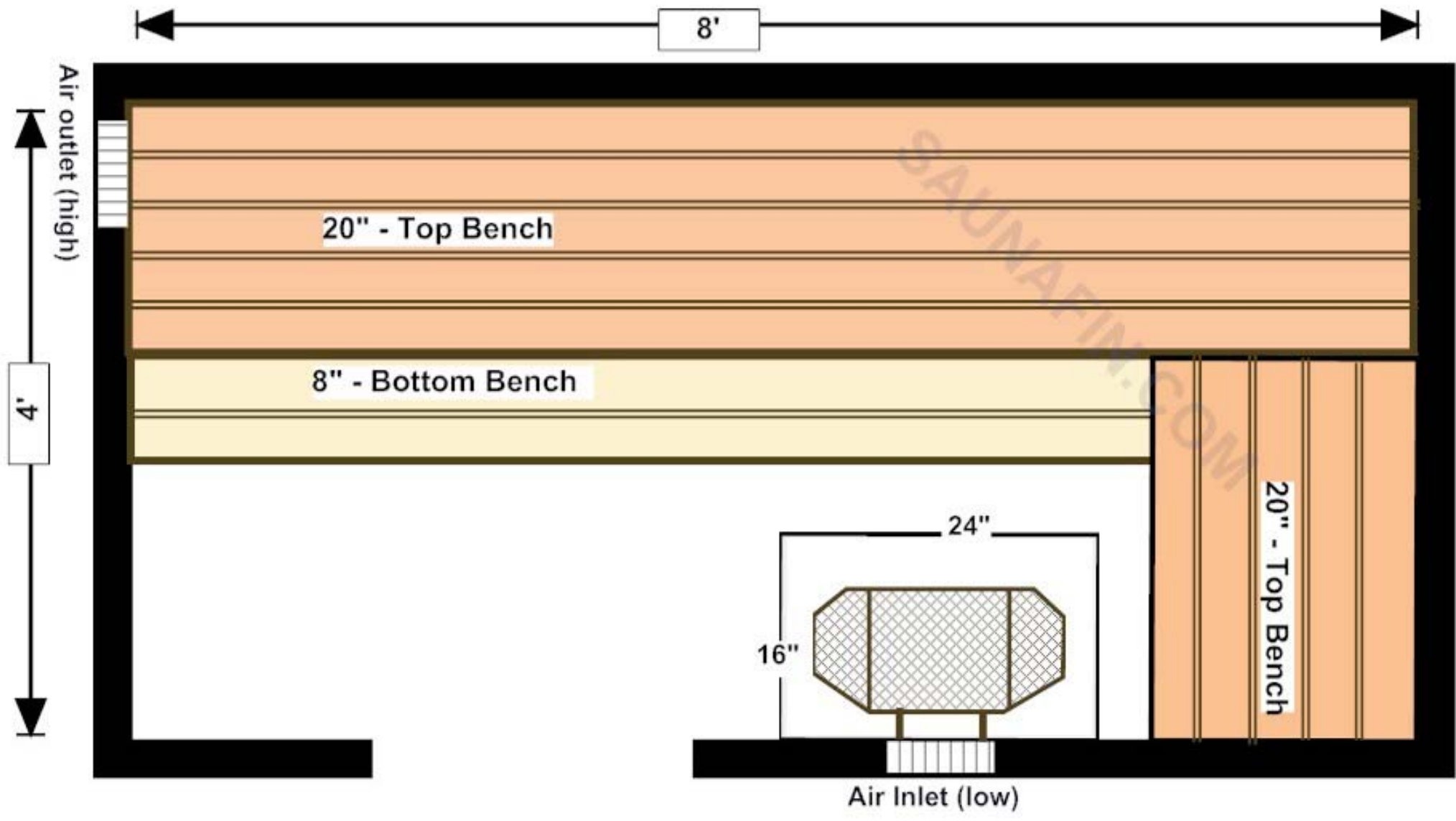



8'

20" - Top Bench

8" - Bottom Bench

20" - Top Bench

8" - Bottom Bench

4'

24"

16"

Air Inlet (low)

Air outlet (high)

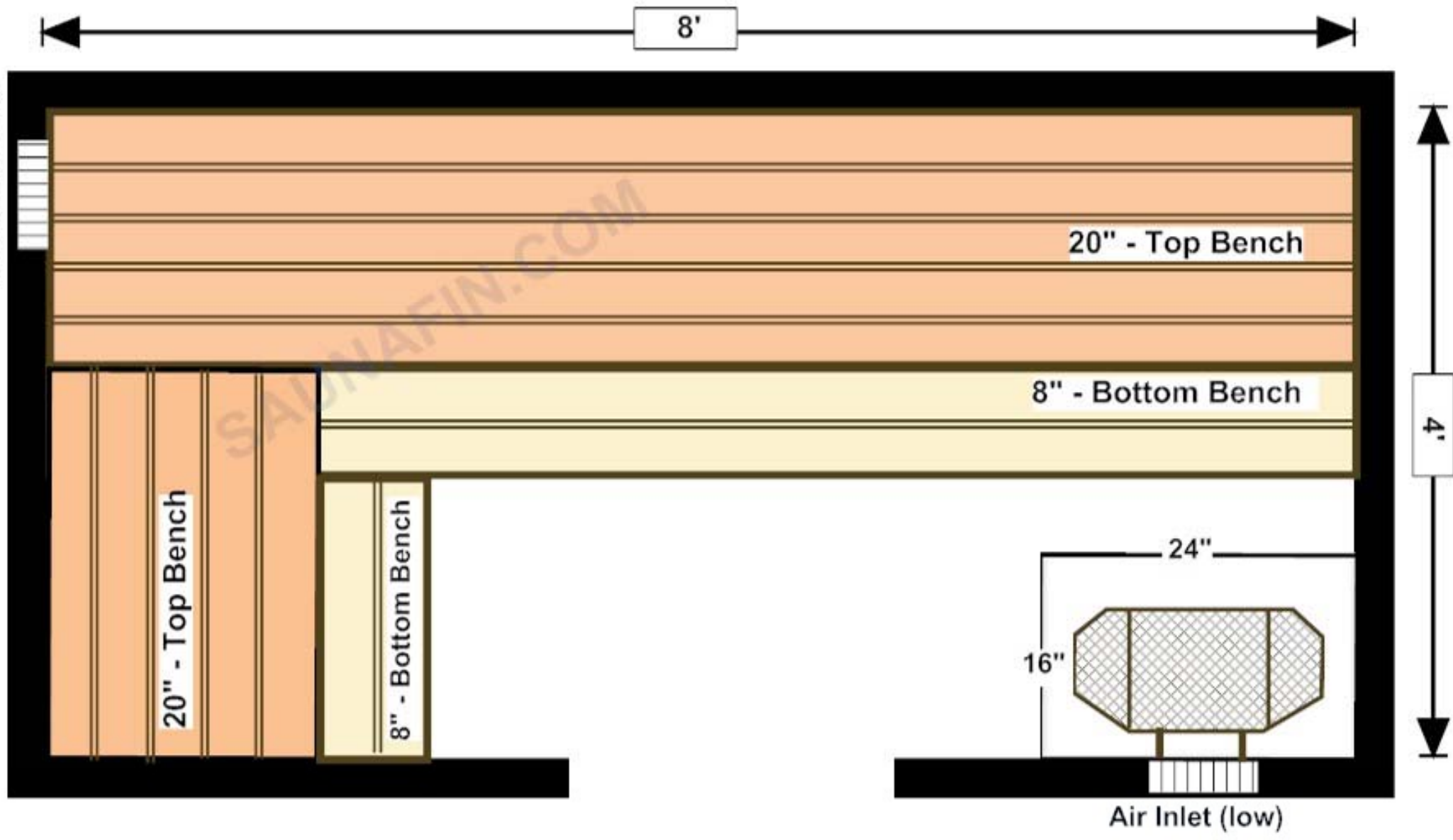

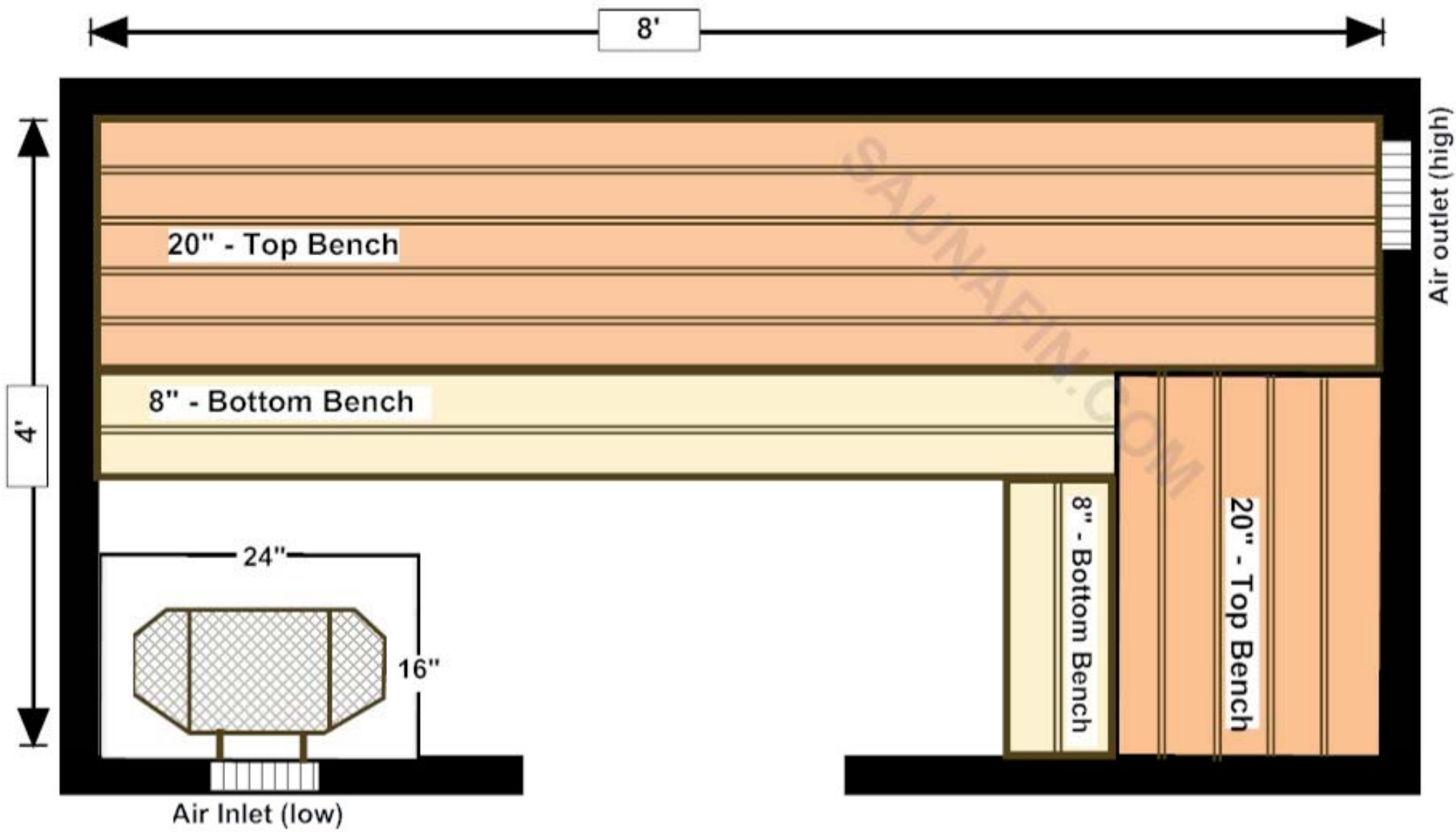

Air outlet (high)

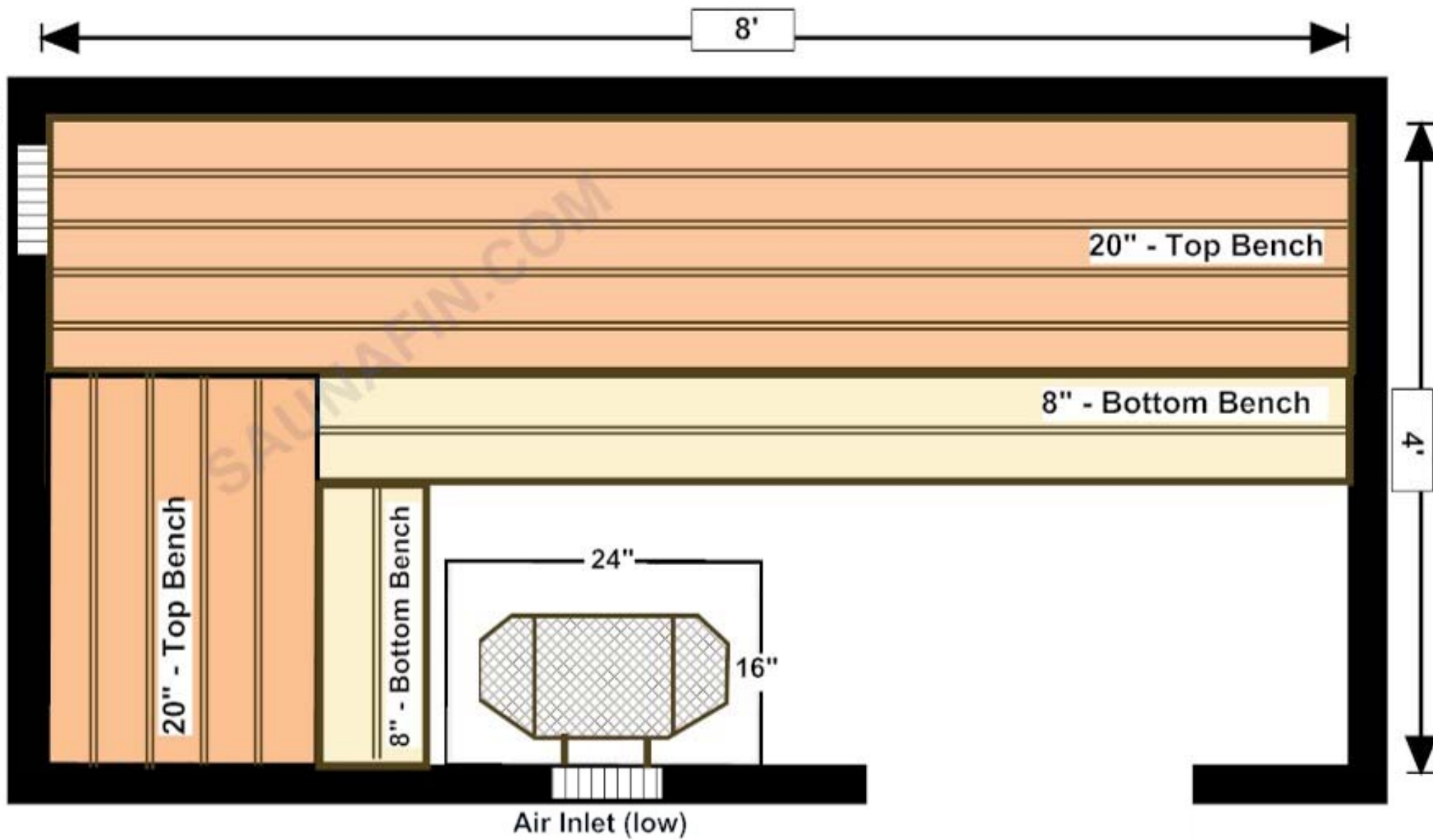

8'

20" - Top Bench

8" - Bottom Bench

20" - Top Bench

8" - Bottom Bench

24"

16"

Air Inlet (low)

4'